



ANOS



Criando produtos para uma vida melhor.

CARTA DO PRESIDENTE

Era o ano de 1946 quando imigrantes espanhóis à procura de uma vida melhor no Brasil, decidiram se juntar e abriram uma pequena loja de fabricação e comercialização de guarda chuvas, no bairro Botafogo na cidade do Rio de Janeiro. Em 1965 meu pai Francisco Conde Masid, ingressou nesta sociedade. Em 1990, em decorrência de um acidente automobilístico, meu pai faleceu. Eu tinha apenas treze anos de idade, mas compreendi que precisava ajudar minha mãe a cuidar da família. Meu pai ensinou-me a importância do trabalho e valores como honestidade e perseverança, foi por isso que levantei a cabeça, comecei a trabalhar na loja e fui aprendendo tudo o que podia dentro do processo. Quero destacar o papel importantíssimo de minha mãe, Noemis Pinheiro, que apesar da minha pouca idade, viu em mim uma veia empreendedora e teve coragem e visão em me colocar a frente dos negócios da família.

Fui crescendo e ganhando o respeito dos sócios, destaco a figura do Sr. Mário Laso, que aos poucos foi me inserindo na participação da gestão da loja, quando eu tinha dezesseis anos.

No ano de 1997 decidimos ampliar o mix de produtos iniciando a fabricação de cadeiras de praia. Com muito trabalho e esforço, fomos crescendo e conseguimos mudar para um local maior na Avenida Brasil. Em 1999 iniciamos a fabricação de escadas e varais e nos instalamos no bairro de Bonsucesso, a essa altura já contávamos com um quadro de 60 funcionários.

A inserção de novos produtos fez com que nossas vendas aumentassem consideravelmente, dessa forma, em 2003 abrimos a nossa primeira fábrica na cidade de Duque de Caxias, com 12.300m² de terreno e 8.000m² de galpão.

Instalados na fábrica, o nosso crescimento acelerou e em 2007 já éramos considerados um dos grandes fabricantes de escadas do mercado. Motivados pela atual bonança econômica do país, decidimos abrir outro polo de produção na cidade de Três Rios, no ano de 2009.

Em 2011 dei um grande passo, fiz a aquisição do restante das participações societárias da empresa e decidi investir tudo na construção de um novo complexo industrial de 70.000m² na cidade de Paracambi. As obras iniciaram em 2012 e em 2013 iniciamos a contratação de funcionários. Agradeço profundamente o povo de Paracambi e arredores, que me acolheram e sonharam junto comigo.

Em 2021 completamos 75 anos de história, pela qual sinto um profundo orgulho e contentamento. Hoje os nossos produtos podem ser comprados em mais de 25.000 pontos de vendas em 8 países. Com muita satisfação, posso falar que somos o maior e mais completo fabricante de escadas do Brasil e o maior da América do Sul, também somos reconhecidos pela qualidade dos nossos produtos para lazer como cadeiras de praia, guarda sóis e acessórios para o bem viver.

Me enche de orgulho viajar pelo nosso país e ver os produtos Botafogo enfeitando os lares e as mais belas praias do mundo.

Juan C. C. Pinheiro



Criando produtos para uma vida melhor.



15 DEGRAUS
REF.: EFR9928



**GARANTIA
1 ANO**



Indicado para até
150kg

NCM
3925.90.90

ALTURAS

	FECHADA	ESTENDIDA ÚTIL
13 D +(4)	3,29 m	4,25 m
15 D +(4)	3,59 m	4,85 m
17 D +(4)	3,89 m	5,45 m
19 D +(4)	4,19 m	6,05 m
21 D +(4)	4,49 m	6,65 m
23 D +(4)	4,79 m	7,25 m
25 D +(4)	5,09 m	7,85 m
27 D +(4)	5,39 m	8,45 m
29 D +(4)	5,69 m	9,05 m
31 D +(4)	5,99 m	9,65 m



PRODUTO

ESCADA DE FIBRA EXTENSÍVEL	REFERÊNCIA	GTIN 13	PESO LÍQUIDO	TAMANHO ABERTO (LxCxA)
PROF. ROBUSTA 13D + (4) 4,25m	EFR9927	789896319927-4	18,41 (kg)	44,5 x 14,5 x 425,0 (cm)
PROF. ROBUSTA 15D + (4) 4,85m	EFR9928	789896319928-1	20,04 (kg)	44,5 x 14,5 x 485,0 (cm)
PROF. ROBUSTA 17D + (4) 5,45m	EFR9929	789896319929-8	21,67 (kg)	44,5 x 14,5 x 545,0 (cm)
PROF. ROBUSTA 19D + (4) 6,05m	EFR9930	789896319930-4	23,30 (kg)	44,5 x 14,5 x 605,0 (cm)
PROF. ROBUSTA 21D + (4) 6,65m	EFR9931	789896319931-1	24,43 (kg)	44,5 x 14,5 x 665,0 (cm)
PROF. ROBUSTA 23D + (4) 7,25m	EFR9932	789896319932-8	26,47 (kg)	44,5 x 14,5 x 725,0 (cm)
PROF. ROBUSTA 25D + (4) 7,85m	EFR9933	789896319933-5	27,68 (kg)	44,5 x 14,5 x 785,0 (cm)
PROF. ROBUSTA 27D + (4) 8,45m	EFR9934	789896319934-2	29,30 (kg)	44,5 x 14,5 x 845,0 (cm)
PROF. ROBUSTA 29D + (4) 9,05m	EFR9935	789896319935-9	30,93 (kg)	44,5 x 14,5 x 905,0 (cm)
PROF. ROBUSTA 31D + (4) 9,65m	EFR9936	789896319936-6	32,56 (kg)	44,5 x 14,5 x 965,0 (cm)

EMBALAGEM

EMBALAGEM	TAMANHO (LxCxA)	VOLUME	PESO BRUTO
01	46,0 x 15,5 x 329,5 (cm)	0,234 m³	18,63 (kg)
01	46,0 x 15,5 x 359,5 (cm)	0,256 m³	20,28 (kg)
01	46,0 x 15,5 x 389,5 (cm)	0,277 m³	21,93 (kg)
01	46,0 x 15,5 x 419,5 (cm)	0,299 m³	23,58 (kg)
01	46,0 x 15,5 x 449,5 (cm)	0,320 m³	24,74 (kg)
01	46,0 x 15,5 x 479,5 (cm)	0,341 m³	26,80 (kg)
01	46,0 x 15,5 x 509,5 (cm)	0,363 m³	28,03 (kg)
01	46,0 x 15,5 x 539,5 (cm)	0,384 m³	29,67 (kg)
01	46,0 x 15,5 x 569,5 (cm)	0,406 m³	31,32 (kg)
01	46,0 x 15,5 x 599,5 (cm)	0,427 m³	32,97 (kg)

Indicado para até
120kg

NCM
3925.90.90

ALTURAS

FECHADA

ESTENDIDA ÚTIL

11 D +(4)	3,29 m	4,25 m
13 D +(4)	3,59 m	4,85 m
15 D +(4)	3,89 m	5,45 m
17 D +(4)	4,19 m	6,05 m
19 D +(4)	4,49 m	6,65 m

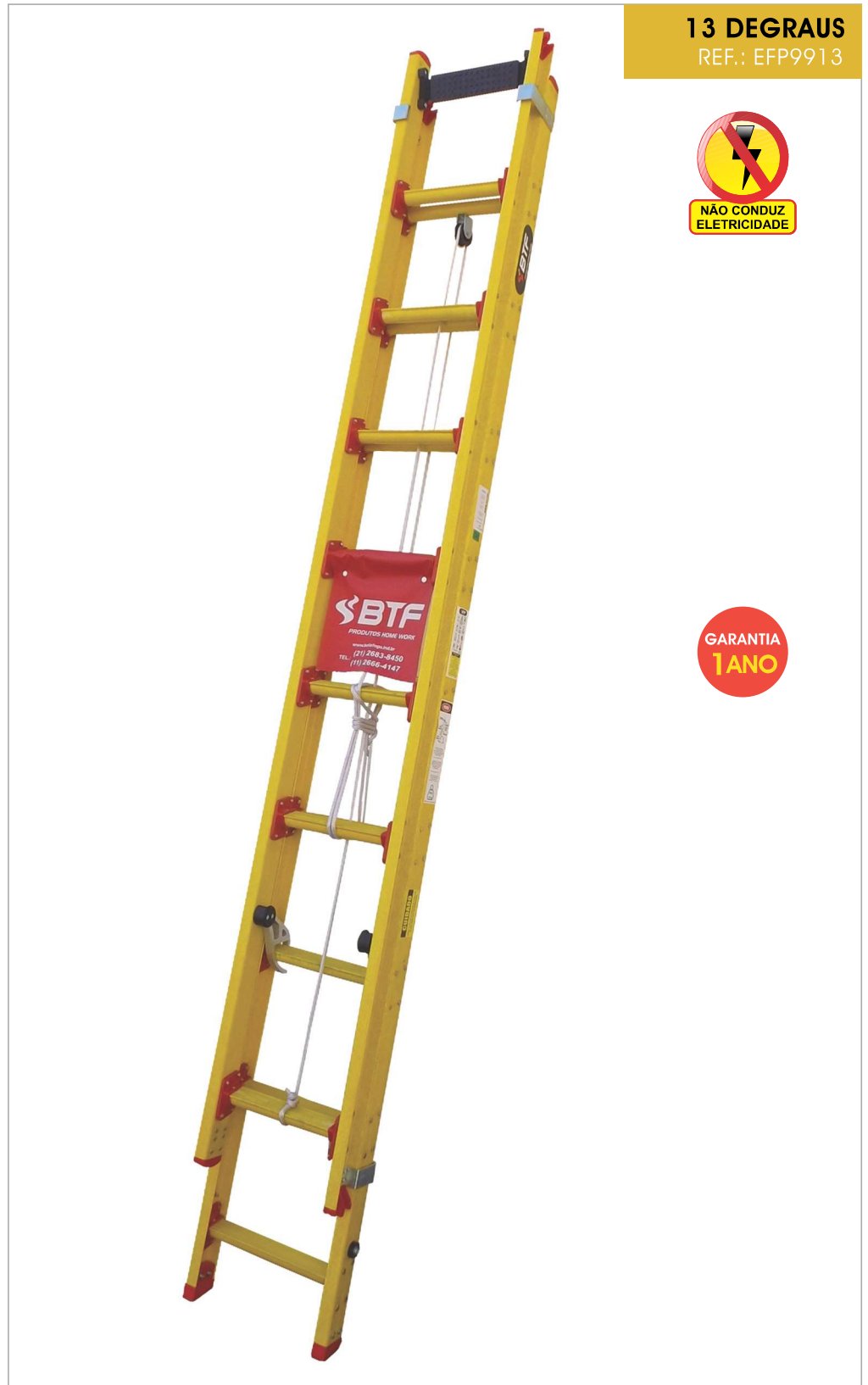

13 DEGRAUS
REF.: EFP9913



PRODUTO					EMBALAGEM			
ESCADA DE FIBRA EXTENSÍVEL	REFERÊNCIA	GTIN 13	PESO LÍQUIDO	TAMANHO ABERTO (LxCxA)	EMBALAGEM	TAMANHO (LxCxA)	VOLUME	PESO BRUTO
PRÁTICA 11D + (4) 4,25m	EFP9911	789896319911-3	11,21 (kg)	38,0 x 14,0 x 425,0 (cm)	01	38,5 x 14,5 x 329,5 (cm)	0,175 m³	11,37 (kg)
PRÁTICA 13D + (4) 4,85m	EFP9913	789896319913-7	12,61 (kg)	38,0 x 14,0 x 485,0 (cm)	01	38,5 x 14,5 x 359,5 (cm)	0,191 m³	12,78 (kg)
PRÁTICA 15D + (4) 5,45m	EFP9915	789896319915-1	14,02 (kg)	38,0 x 14,0 x 545,0 (cm)	01	38,5 x 14,5 x 389,5 (cm)	0,207 m³	14,20 (kg)
PRÁTICA 17D + (4) 6,05m	EFP9917	789896319917-5	15,53 (kg)	38,0 x 14,0 x 605,0 (cm)	01	38,5 x 14,5 x 419,5 (cm)	0,223 m³	15,72 (kg)
PRÁTICA 19D + (4) 6,65m	EFP9919	789896319919-9	16,97 (kg)	38,0 x 14,0 x 665,0 (cm)	01	38,5 x 14,5 x 449,5 (cm)	0,239 m³	17,17 (kg)

07 DEGRAUS

REF.: EFR9921



GARANTIA
1 ANO



Indicado para até
150kg

NCM
3925.90.90

ALTURAS

ABERTA

05 D	0,99 m
07 D	1,25 m
09 D	1,49 m
11 D	1,75 m
13 D	2,01 m
15 D	2,24 m
17 D	2,47 m

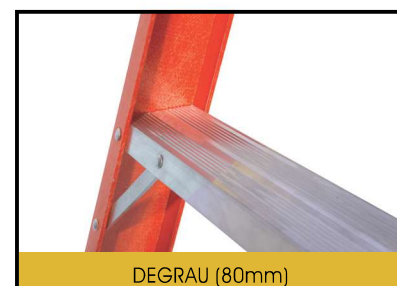

PRODUTO

ESCADA DE FIBRA TESOURA	REFERÊNCIA	GTIN 13	PESO LÍQUIDO	TAMANHO ABERTO (LxCxA)
DUPLO ACESSO ROBUSTA 05 D	EFR9920	789896319920-5	9,83(kg)	46,0 x 97,0 x 99,5 (cm)
DUPLO ACESSO ROBUSTA 07 D	EFR9921	789896319921-2	13,22 (kg)	51,5 x 128,5 x 125,0 (cm)
DUPLO ACESSO ROBUSTA 09 D	EFR9922	789896319922-9	16,67 (kg)	57,5 x 158,5 x 149,5 (cm)
DUPLO ACESSO ROBUSTA 11 D	EFR9923	789896319923-6	20,81 (kg)	63,5 x 188,0 x 175,3 (cm)
DUPLO ACESSO ROBUSTA 13 D	EFR9924	789896319924-3	24,61 (kg)	69,0 x 221,0 x 201,0 (cm)
DUPLO ACESSO ROBUSTA 15 D	EFR9925	789896319925-0	28,14 (kg)	75,0 x 252,0 x 224,0 (cm)
DUPLO ACESSO ROBUSTA 17 D	EFR9926	789896319926-7	32,98 (kg)	81,5 x 282,0 x 247,0 (cm)

EMBALAGEM

EMBALAGEM	TAMANHO (LxCxA)	VOLUME	PESO BRUTO
01	46,0 x 22,0 x 141,0 (cm)	0,143 m³	9,93 (kg)
01	51,5 x 22,0 x 198,5 (cm)	0,225 m³	13,32 (kg)
01	57,5 x 22,0 x 255,5 (cm)	0,323 m³	16,87 (kg)
01	63,5 x 22,0 x 315,5 (cm)	0,441 m³	21,04 (kg)
01	69,0 x 22,0 x 371,0 (cm)	0,563 m³	24,81 (kg)
01	75,0 x 22,0 x 430,0 (cm)	0,710 m³	28,55 (kg)
01	81,5 x 22,0 x 489,0 (cm)	0,877 m³	33,28 (kg)

Indicado para até
120kg

NCM
3925.90.90

ALTURAS

ABERTA

04 D	1,19 m
05 D	1,43 m
06 D	1,67 m
07 D	1,91 m
08 D	2,16 m
09 D	2,41 m
10 D	2,65 m

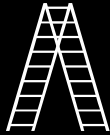

05 DEGRAUS

REF.: EFP9905



PRODUTO					EMBALAGEM			
ESCADA DE FIBRA TESOURA	REFERÊNCIA	GTIN 13	PESO LÍQUIDO	TAMANHO ABERTO (LxCxA)	EMBALAGEM	TAMANHO (LxCxA)	VOLUME	PESO BRUTO
DUPLO ACESSO PRÁTICA 4 D	EFP9904	789896319904-5	7,62 (kg)	43,6 x 77,4 x 119,0 (cm)	01	43,8 x 16,5 x 128,5 (cm)	0,092 m³	7,72 (kg)
DUPLO ACESSO PRÁTICA 5 D	EFP9905	789896319905-2	8,92 (kg)	46,2 x 90,7 x 143,7 (cm)	01	46,2 x 16,5 x 153,5 (cm)	0,117 m³	9,05 (kg)
DUPLO ACESSO PRÁTICA 6 D	EFP9906	789896319906-9	10,45 (kg)	48,8 x 104,0 x 167,7 (cm)	01	48,8 x 16,5 x 178,5 (cm)	0,143 m³	10,61 (kg)
DUPLO ACESSO PRÁTICA 7 D	EFP9907	789896319907-6	11,85 (kg)	51,4 x 117,3 x 191,0 (cm)	01	52,0 x 16,5 x 200,5 (cm)	0,172 m³	11,98 (kg)
DUPLO ACESSO PRÁTICA 8 D	EFP9908	789896319908-3	13,63 (kg)	53,7 x 130,0 x 216,0 (cm)	01	53,7 x 16,5 x 227,0 (cm)	0,201 m³	13,84 (kg)
DUPLO ACESSO PRÁTICA 9 D	EFP9909	789896319909-0	15,08 (kg)	56,0 x 135,2 x 241,0 (cm)	01	56,0 x 16,5 x 253,5 (cm)	0,234 m³	15,28 (kg)
DUPLO ACESSO PRÁTICA 10 D	EFP9910	789896319910-6	16,67 (kg)	58,6 x 148,5 x 265,0 (cm)	01	59,5 x 16,5 x 273,0 (cm)	0,268 m³	16,83 (kg)

06 DEGRAUS

REF.: EFP9901



GARANTIA
1 ANO

Indicado para até
120kgNCM
3925.90.90

ALTURAS

ABERTA

03 D	0,93 m
04 D	1,18 m
05 D	1,41 m
06 D	1,64 m
07 D	1,90 m
08 D	2,13 m



PRODUTO

ESCADA DE FIBRA TESOURA	REFERÊNCIA	GTIN 13	PESO LÍQUIDO	TAMANHO ABERTO (LxCxA)
PRÁTICA 3 D	EFP5907	789899415907-0	3,965 (kg)	41,2 x 61,5 x 93,0 (cm)
PRÁTICA 4 D	EFP5908	789899415908-7	4,755 (kg)	43,2 x 75,2 x 118,0 (cm)
PRÁTICA 5 D	EFP5909	789899415909-4	5,490 (kg)	46,0 x 87,0 x 141,5 (cm)
PRÁTICA 6 D	EFP9901	789896319901-4	6,270 (kg)	48,7 x 99,5 x 164,5 (cm)
PRÁTICA 7 D	EFP9902	789896319902-1	7,205 (kg)	51,0 x 114,5 x 190,0 (cm)
PRÁTICA 8 D	EFP9903	789896319903-8	8,090 (kg)	53,3 x 127,0 x 213,5 (cm)

EMBALAGEM

EMBALAGEM	TAMANHO (LxCxA)	VOLUME	PESO BRUTO
01	41,2 x 16,5 x 99,5 (cm)	0,067 m³	4,075 (kg)
01	43,2 x 16,5 x 125,0 (cm)	0,089 m³	4,870 (kg)
01	46,0 x 16,5 x 149,5 (cm)	0,113 m³	5,625 (kg)
01	48,7 x 16,5 x 175,3 (cm)	0,140 m³	6,560 (kg)
01	51,0 x 16,5 x 201,0 (cm)	0,169 m³	7,385 (kg)
01	53,3 x 16,5 x 222,4 (cm)	0,196 m³	8,280 (kg)

Indicado para até
120kg

NCM
7616.99.00

ALTURAS

ABERTA

03 D	0,93 m
04 D	1,18 m
05 D	1,41 m
06 D	1,64 m
07 D	1,90 m
08 D	2,13 m

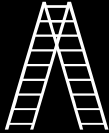

5 DEGRAUS
REF.: EAP5905



PRODUTO					EMBALAGEM			
ESCADA DE ALUMÍNIO	REFERÊNCIA	GTIN 13	PESO LÍQUIDO	TAMANHO ABERTO (LxCxA)	EMBALAGEM	TAMANHO (LxCxA)	VOLUME	PESO BRUTO
TESOURA PRÁTICA 3 D	EAP5903	790815540678-0	3,83 (kg)	41,2 x 61,5 x 93,0 (cm)	01	41,2 x 16,5 x 99,5 (cm)	0,067 m³	3,93 (kg)
TESOURA PRÁTICA 4 D	EAP5904	790815540677-3	4,39 (kg)	43,2 x 75,2 x 118,0 (cm)	01	43,2 x 16,5 x 125,0 (cm)	0,089 m³	4,24 (kg)
TESOURA PRÁTICA 5 D	EAP5905	790815540676-6	5,07 (kg)	46,0 x 87,0 x 141,5 (cm)	01	46,0 x 16,5 x 149,5 (cm)	0,113 m³	5,19 (kg)
TESOURA PRÁTICA 6 D	EAP5906	790815540675-9	5,75 (kg)	48,7 x 99,5 x 164,5 (cm)	01	48,7 x 16,5 x 175,3 (cm)	0,140 m³	5,88 (kg)
TESOURA PRÁTICA 7 D	EAP5907	790815540674-2	6,68 (kg)	51,0 x 114,5 x 190,0 (cm)	01	51,0 x 16,5 x 201,0 (cm)	0,169 m³	6,83 (kg)
TESOURA PRÁTICA 8 D	EAP5908	790815540673-5	7,30 (kg)	53,3 x 127,0 x 213,5 (cm)	01	53,3 x 16,5 x 224,0 (cm)	0,196 m³	7,45 (kg)

2X9 DEGRAUS

REF.: ESC0618

 GARANTIA
1 ANO
Indicado para até
150kg**NCM**
7616.99.00

ALTURAS

ESTENDIDA

5 X 2 D	2,20 m
6 X 2 D	2,76 m
7 X 2 D	3,32 m
8 X 2 D	4,10 m
9 X 2 D	4,44 m
10 X 2 D	5,00 m
11 X 2 D	5,76 m
12 X 2 D	6,12 m
13 X 2 D	6,93 m
14 X 2 D	7,45 m
15 X 2 D	7,80 m



FECHADA

5 X 2 D	1,56 m
6 X 2 D	1,85 m
7 X 2 D	2,12 m
8 X 2 D	2,48 m
9 X 2 D	2,68 m
10 X 2 D	2,96 m
11 X 2 D	3,24 m
12 X 2 D	3,52 m
13 X 2 D	3,81 m
14 X 2 D	4,18 m
15 X 2 D	4,36 m



PINTOR

5 X 2 D	1,31 m
6 X 2 D	1,56 m
7 X 2 D	1,84 m
8 X 2 D	2,07 m
9 X 2 D	2,35 m
10 X 2 D	2,62 m
11 X 2 D	3,06 m
12 X 2 D	3,13 m
13 X 2 D	3,46 m
14 X 2 D	3,84 m
15 X 2 D	4,04 m



BARRA ESTABILIZADORA

PRODUTO

ESCADA DE ALUMÍNIO	REFERÊNCIA	GTIN 13	PESO LÍQUIDO	TAMANHO ABERTO (LxCxA)
EXTENSÍVEL 5X2 D	ESC0614	790815540271-3	6,12 (kg)	62,7 x 94,0 x 131,5 (cm)
EXTENSÍVEL 6X2 D	ESC0615	790815540272-0	6,92 (kg)	62,7 x 95,0 x 155,9 (cm)
EXTENSÍVEL 7X2 D	ESC0616	790815540273-7	7,91 (kg)	62,7 x 124,0 x 184,0 (cm)
EXTENSÍVEL 8X2 D	ESC0617	790815540274-4	8,90 (kg)	62,7 x 154,5 x 207,5 (cm)
EXTENSÍVEL 9X2 D	ESC0618	790815540275-1	9,36 (kg)	62,7 x 173,0 x 235,0 (cm)
EXTENSÍVEL 10X2 D	ESC0619	790815540276-8	11,09 (kg)	72,3 x 190,5 x 262,0 (cm)
EXTENSÍVEL 11X2 D	ESC0620	790815540277-5	12,02 (kg)	72,3 x 217,5 x 306,0 (cm)
EXTENSÍVEL 12X2 D	ESC0621	790815540278-2	13,02 (kg)	72,3 x 237,5 x 313,5 (cm)
EXTENSÍVEL 13X2 D	ESC0622	790815540279-9	13,88 (kg)	72,3 x 257,5 x 343,5 (cm)
EXTENSÍVEL 14X2 D	ESC0623	790815540280-5	14,86 (kg)	93,0 x 274,0 x 384,0 (cm)
EXTENSÍVEL 15X2 D	ESC0624	790815540281-2	16,40 (kg)	93,0 x 304,0 x 404,0 (cm)

EMBALAGEM

EMBALAGEM	TAMANHO (LxCxA)	VOLUME	PESO BRUTO
01	41,0 x 14,0 x 156,5 (cm)	0,089 m³	6,24 (kg)
01	41,0 x 14,0 x 185,5 (cm)	0,106 m³	7,05 (kg)
01	41,0 x 14,0 x 212,5 (cm)	0,121 m³	8,04 (kg)
01	41,0 x 14,0 x 240,5 (cm)	0,138 m³	9,04 (kg)
01	41,0 x 14,0 x 268,5 (cm)	0,154 m³	9,50 (kg)
01	41,0 x 14,0 x 296,5 (cm)	0,170 m³	11,25 (kg)
01	41,0 x 14,0 x 324,5 (cm)	0,186 m³	12,17 (kg)
01	41,0 x 14,0 x 352,5 (cm)	0,202 m³	13,18 (kg)
01	41,0 x 14,0 x 380,5 (cm)	0,218 m³	14,05 (kg)
01	41,0 x 14,0 x 408,5 (cm)	0,234 m³	15,04 (kg)
01	41,0 x 14,0 x 436,5 (cm)	0,250 m³	16,61 (kg)

Indicado para até
150kg

NCM
7616.99.00

ALTURAS

05 D	1,53 m
06 D	1,81 m
07 D	2,09 m
08 D	2,37 m
09 D	2,65 m
10 D	2,93 m
11 D	3,21 m
12 D	3,49 m
13 D	3,77 m
14 D	4,05 m
15 D	4,33 m



9 DEGRAUS
REF.: ESC0607



GARANTIA
1 ANO



PRODUTO					EMBALAGEM			
ESCADA DE ALUMÍNIO	REFERÊNCIA	GTIN 13	PESO LÍQUIDO	TAMANHO ABERTO (LxCxA)	EMBALAGEM	TAMANHO (LxCxA)	VOLUME	PESO BRUTO
PARALELA 05 D	ESC0603	790815540282-9	2,42 (kg)	41,0 x 6,4 x 153,0 (cm)	01	41,0 x 6,5 x 153,5 (cm)	0,041 m³	2,51 (kg)
PARALELA 06 D	ESC0604	790815540283-6	2,86 (kg)	41,0 x 6,4 x 181,0 (cm)	01	41,0 x 6,5 x 181,5 (cm)	0,048 m³	2,96 (kg)
PARALELA 07 D	ESC0605	790815540284-3	3,30 (kg)	41,0 x 6,4 x 209,0 (cm)	01	41,0 x 6,5 x 209,5 (cm)	0,056 m³	3,41 (kg)
PARALELA 08 D	ESC0606	790815540285-0	3,74 (kg)	41,0 x 6,4 x 237,0 (cm)	01	41,0 x 6,5 x 237,5 (cm)	0,063 m³	3,86 (kg)
PARALELA 09 D	ESC0607	790815540286-7	4,18 (kg)	41,0 x 6,4 x 265,0 (cm)	01	41,0 x 6,5 x 265,5 (cm)	0,071 m³	4,31 (kg)
PARALELA 10 D	ESC0608	790815540287-4	4,62 (kg)	41,0 x 6,4 x 293,0 (cm)	01	41,0 x 6,5 x 293,5 (cm)	0,078 m³	4,76 (kg)
PARALELA 11 D	ESC0609	790815540288-1	5,06 (kg)	41,0 x 6,4 x 321,0 (cm)	01	41,0 x 6,5 x 321,5 (cm)	0,086 m³	5,21 (kg)
PARALELA 12 D	ESC0610	790815540289-8	5,50 (kg)	41,0 x 6,4 x 349,0 (cm)	01	41,0 x 6,5 x 349,5 (cm)	0,093 m³	5,66 (kg)
PARALELA 13 D	ESC0611	790815540290-4	5,94 (kg)	41,0 x 6,4 x 377,0 (cm)	01	41,0 x 6,5 x 377,5 (cm)	0,101 m³	6,11 (kg)
PARALELA 14 D	ESC0612	790815540291-1	6,38 (kg)	41,0 x 6,4 x 405,0 (cm)	01	41,0 x 6,5 x 405,5 (cm)	0,108 m³	6,56 (kg)
PARALELA 15 D	ESC0613	790815540292-8	6,82 (kg)	41,0 x 6,4 x 433,0 (cm)	01	41,0 x 6,5 x 433,5 (cm)	0,116 m³	7,01 (kg)

8x2 DEGRAUS

REF.: ESC0579



 GARANTIA
1 ANO
Indicado para até
150kg**NCM**
7616.99.00**ALTURAS****ESTENDIDA**

5x2 D	2,98 m
6x2 D	3,54 m
7x2 D	4,10 m
8x2 D	4,66 m
9x2 D	5,22 m

**PINTOR**

5x2 D	1,46 m
6x2 D	1,72 m
7x2 D	1,98 m
8x2 D	2,25 m
9x2 D	2,52 m



ARTICULAÇÃO PRECISA



BARRA ESTABILIZADORA

PRODUTO

ESCADA DE ALUMÍNIO	REFERÊNCIA	GTIN 13	PESO LÍQUIDO	TAMANHO ABERTO (LxCxA)
MULTIFUNÇÃO 5x2 D	ESC0576	790815540295-9	6,26 (kg)	63,0 x 103,0 x 146,0 (cm)
MULTIFUNÇÃO 6x2 D	ESC0577	790815540296-6	7,49 (kg)	63,0 x 120,5 x 172,0 (cm)
MULTIFUNÇÃO 7x2 D	ESC0578	790815540297-3	8,72 (kg)	63,0 x 138,0 x 198,0 (cm)
MULTIFUNÇÃO 8x2 D	ESC0579	790815540298-0	8,91 (kg)	63,0 x 155,0 x 225,0 (cm)
MULTIFUNÇÃO 9x2 D	ESC0580	790815540299-7	10,14 (kg)	63,0 x 172,0 x 252,0 (cm)

EMBALAGEM

EMBALAGEM	TAMANHO (LxCxA)	VOLUME	PESO BRUTO
01	39,0 x 13,0 x 153,3 (cm)	0,078 m³	6,41 (kg)
01	39,0 x 13,0 x 181,0 (cm)	0,092 m³	7,64 (kg)
01	39,0 x 13,0 x 209,0 (cm)	0,106 m³	8,90 (kg)
01	39,0 x 13,0 x 236,5 (cm)	0,120 m³	9,06 (kg)
01	39,0 x 13,0 x 264,5 (cm)	0,134 m³	10,30 (kg)

Indicado para até
150kg

NCM
7616.99.00

ALTURAS

ESTENDIDA

2x4 D 2,23 m
3x4 D 3,23 m
4x4 D 4,23 m
5x4 D 5,23 m



FECHADA

2x4 D 0,64 m
3x4 D 0,89 m
4x4 D 1,14 m
5x4 D 1,39 m



PINTOR

2x4 D 0,97 m
3x4 D 1,45 m
4x4 D 1,91 m
5x4 D 2,40 m



ANDAIME

2x4 D 0,63 m
3x4 D 0,87 m
4x4 D 1,11 m
5x4 D 1,35 m



4x4 DEGRAUS
REF.: ESC0293



GARANTIA
1 ANO



13
POSIÇÕES

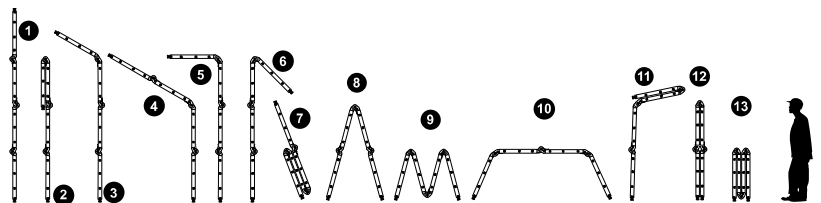

* Para posição 10, recomenda-se o uso de uma plataforma para melhor distribuição do peso.

PRODUTO					EMBALAGEM			
ESCADA DE ALUMÍNIO	REFERÊNCIA	GTIN 13	PESO LÍQUIDO	TAMANHO FECHADO (LxCxA)	EMBALAGEM	TAMANHO (LxCxA)	VOLUME	PESO BRUTO
ARTICULADA 2x4 D	ESC0291	790815540479-3	9,19 (kg)	62,8 x 28,5 x 64,1 (cm)	01	27,5 x 40,0 x 61,0 (cm)	0,067 m³	9,73 (kg)
ARTICULADA 3x4 D	ESC0292	790815540293-5	10,84 (kg)	62,8 x 28,5 x 89,0 (cm)	01	27,5 x 40,0 x 86,0 (cm)	0,094 m³	11,37 (kg)
ARTICULADA 4x4 D	ESC0293	790815540294-2	12,42 (kg)	62,8 x 28,5 x 114,0 (cm)	01	27,5 x 40,0 x 111,0 (cm)	0,122 m³	12,79 (kg)
ARTICULADA 5x4 D	ESC0294	790815540480-9	14,26 (kg)	72,8 x 28,5 x 139,0 (cm)	01	27,5 x 40,0 x 136,0 (cm)	0,149 m³	14,63 (kg)

5 DEGRAUS

REF.: ESC0005



 GARANTIA
3 ANOS
SegurançaRegistro
007519/2020

Compulsório

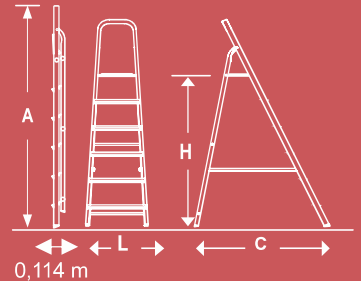
Indicado para até
150kg**NCM**
7616.99.00**MEDIDAS (m)**

	A	L	H	C
02 D	1,11	0,38	0,43	0,48
03 D	1,37	0,41	0,68	0,61
04 D	1,63	0,44	0,92	0,75
05 D	1,89	0,46	1,16	0,89
06 D	2,14	0,49	1,41	1,02
07 D	2,40	0,52	1,65	1,19
08 D	2,89	0,54	2,14	1,34

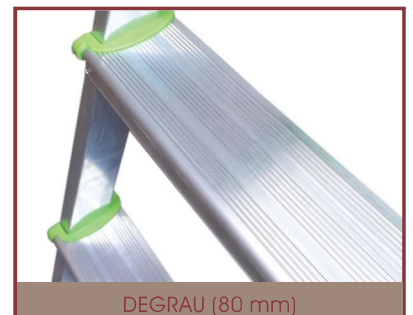
**PRODUTO**

ESCADA DE ALUMÍNIO	REFERÊNCIA	GTIN 13	PESO LÍQUIDO	TAMANHO ABERTO (LxCxH)
DOMÉSTICA EURO 2 D	ESC0002	790815540638-4	2,25 (kg)	38,2 x 47,5 x 43,0 (cm)
DOMÉSTICA EURO 3 D	ESC0003	790815540639-1	2,74 (kg)	41,0 x 61,2 x 68,0 (cm)
DOMÉSTICA EURO 4 D	ESC0004	790815540640-7	3,31 (kg)	44,0 x 75,7 x 92,0 (cm)
DOMÉSTICA EURO 5 D	ESC0005	790815540641-4	4,05 (kg)	46,5 x 89,0 x 116,0 (cm)
DOMÉSTICA EURO 6 D	ESC0006	790815540642-1	4,66 (kg)	49,0 x 102,7 x 141,0 (cm)
DOMÉSTICA EURO 7 D	ESC0007	790815540643-8	5,36 (kg)	52,0 x 119,5 x 165,0 (cm)
DOMÉSTICA EURO 8 D	ESC0008	790815540645-2	6,04 (kg)	54,8 x 134,5 x 214,0 (cm)

EMBALAGEM

EMBALAGEM	TAMANHO (LxCxA)	VOLUME	PESO BRUTO
02	38,2 x 22,8 x 111,0 (cm)	0,09 m ³	4,56 (kg)
02	41,0 x 22,8 x 137,5 (cm)	0,128 m ³	5,55 (kg)
02	44,0 x 22,8 x 163,2 (cm)	0,163 m ³	6,71 (kg)
02	46,5 x 22,8 x 189,0 (cm)	0,200 m ³	8,20 (kg)
02	49,0 x 22,8 x 214,6 (cm)	0,239 m ³	9,44 (kg)
02	52,0 x 22,8 x 240,8 (cm)	0,285 m ³	10,85 (kg)
02	54,8 x 22,8 x 289,6 (cm)	0,361 m ³	12,23 (kg)

Indicado para até
120kg

NCM
7616.99.00

MEDIDAS (m)

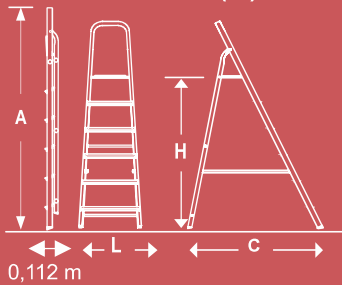

	A	L	H	C
02 D	0,95	0,37	0,42	0,48
03 D	1,16	0,39	0,63	0,55
04 D	1,39	0,41	0,85	0,67
05 D	1,62	0,44	1,07	0,78
06 D	1,86	0,46	1,29	0,89
07 D	2,09	0,49	1,51	1,00
08 D	2,32	0,51	1,73	1,11
09 D	2,55	0,54	1,95	1,23



PATAMAR DE POLIPROPILENO



DEGRAU (75 mm)



5 DEGRAUS
REF.: ESC0064

GARANTIA
3 ANOS

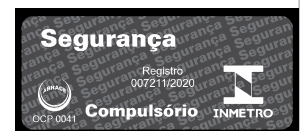

PRODUTO					EMBALAGEM			
ESCADA DE ALUMÍNIO	REFERÊNCIA	GTIN 13	PESO LÍQUIDO	TAMANHO ABERTO (LxCxH)	EMBALAGEM	TAMANHO (LxCxA)	VOLUME	PESO BRUTO
DOMÉSTICA 2 D	ESC0072	790815540300-0	1,61 (kg)	37,8 x 48,5 x 42,0 (cm)	02	37,8 x 22,4 x 95,6 (cm)	0,080 m ³	3,35 (kg)
DOMÉSTICA 3 D	ESC0062	790815540301-7	2,17 (kg)	39,4 x 55,5 x 63,0 (cm)	02	39,4 x 22,4 x 116,4 (cm)	0,102 m ³	4,45 (kg)
DOMÉSTICA 4 D	ESC0063	790815540302-4	2,82 (kg)	41,8 x 66,8 x 85,0 (cm)	02	41,8 x 22,4 x 139,6 (cm)	0,130 m ³	5,74 (kg)
DOMÉSTICA 5 D	ESC0064	790815540303-1	3,09 (kg)	44,2 x 78,0 x 107,0 (cm)	02	44,2 x 22,4 x 162,8 (cm)	0,161 m ³	6,28 (kg)
DOMÉSTICA 6 D	ESC0065	790815540304-8	3,69 (kg)	46,7 x 89,3 x 129,0 (cm)	02	46,7 x 22,4 x 186,0 (cm)	0,194 m ³	7,48 (kg)
DOMÉSTICA 7 D	ESC0066	790815540305-5	4,53 (kg)	49,1 x 100,6 x 151,0 (cm)	02	49,1 x 22,4 x 209,2 (cm)	0,230 m ³	9,16 (kg)
DOMÉSTICA 8 D	ESC0067	790815540306-2	4,67 (kg)	51,5 x 111,9 x 173,0 (cm)	02	51,5 x 22,4 x 232,4 (cm)	0,268 m ³	9,44 (kg)
DOMÉSTICA 9 D	ESC0068	790815540307-9	5,47 (kg)	54,0 x 123,3 x 195,0 (cm)	02	54,0 x 22,4 x 255,7 (cm)	0,309 m ³	11,04 (kg)

02 DEGRAUS

REF.: ESC0070

GARANTIA
1 ANO
SegurançaRegistro
001317/2016

GCP 0041

Compulsório

INMETRO

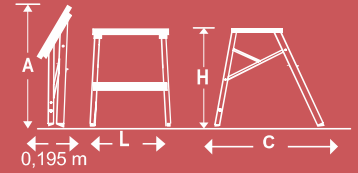
Indicado para até
120kg**NCM**
7616.99.00**MEDIDAS (m)**

	A	L	H	C
02 D	0,55	0,37	0,43	0,41
03 D	0,75	0,39	0,64	0,52



ALÇA PARA TRANSPORTE

03 DEGRAUS

REF.: ESC0071

GARANTIA
1 ANO
SegurançaRegistro
001317/2016

GCP 0041

Compulsório

INMETRO

+19,5 cm+



FÁCIL DE GUARDAR

PRODUTO

ESCALA DE ALUMÍNIO	REFERÊNCIA	GTIN 13	PESO LÍQUIDO	TAMANHO ABERTO (LxCxH)
2 D	ESC0070	790815540606-3	1,54 (kg)	37,5 x 41,0 x 43,0 (cm)
3 D	ESC0071	790815540309-3	1,97 (kg)	39,5 x 52,0 x 64,5 (cm)

EMBALAGEM

EMBALAGEM	TAMANHO (LxCxA)	VOLUME	PESO BRUTO
02	37,5 x 39,0 x 55,0 (cm)	0,080 m ³	3,20 (kg)
02	39,5 x 39,0 x 75,0 (cm)	0,115 m ³	4,09 (kg)

Indicado para até
60kg

NCM
7616.99.00

MEDIDAS (cm)

40 cm
50 cm
60 cm

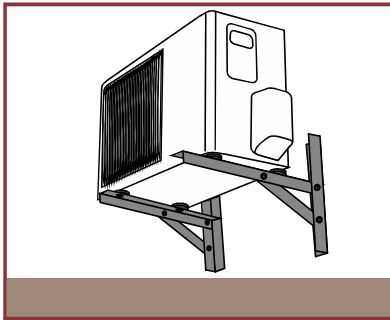

60 cm
REF.: ARC0567

SUPORE DE ALUMÍNIO P/ AR CONDICIONADO DE PAREDE

Indicado para até
60kg

NCM
7616.99.00

INDICAÇÕES (BTU)

6.000 a 7.500
8.300 a 10.000
10.000 a 21.000

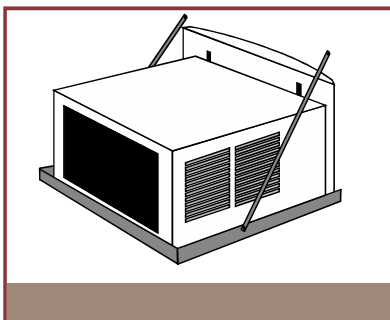

8.300 a 10.000 btu's
REF.: ARC0029

PRODUTO					EMBALAGEM			
SUPORE P/ AR CONDICIONADO	REFERÊNCIA	GTIN 13	PESO LÍQUIDO	TAMANHO ABERTO (LxCxA)	EMBALAGEM	TAMANHO (LxCxA)	VOLUME	PESO BRUTO
TIPO SPLIT 40 cm	ARC0565	790815540319-2	1,25 (kg)	4,0 x 40,0 x 30,0 (cm)	01	6,0 x 45,0 x 6,0 (cm)	0,001 m³	1,32 (kg)
TIPO SPLIT 50 cm	ARC0566	790815540320-8	1,45 (kg)	4,0 x 50,0 x 30,0 (cm)	01	6,0 x 56,0 x 6,0 (cm)	0,002 m³	1,52 (kg)
TIPO SPLIT 60 cm	ARC0567	790815540321-5	1,76 (kg)	4,0 x 60,0 x 30,0 (cm)	01	6,0 x 76,0 x 6,0 (cm)	0,002 m³	1,83 (kg)
DE PAREDE 6.000 A 7.500	ARC0028	790815540316-1	0,82 (kg)	49,7 x 49,6 x 31,0 (cm)	05	13,0 x 7,0 x 8,5 (cm)	0,0007 m³	4,18 (kg)
DE PAREDE 8.300 A 10.000	ARC0029	790815540317-8	0,91 (kg)	54,2 x 59,6 x 31,0 (cm)	05	13,0 x 7,0 x 8,5 (cm)	0,0007 m³	4,61 (kg)
DE PAREDE 10.000 A 21.000	ARC0030	790815540318-5	0,99 (kg)	59,6 x 68,0 x 31,0 (cm)	05	13,0 x 7,8 x 8,5 (cm)	0,0008 m³	5,03 (kg)

CHÃO 120cm

REF.: VAR0222

NCM
 7615.10.00

 80 cm
 100 cm
 120 cm

 8,0 kg
 10,0 kg
 12,0 kg

 6,4 m
 8,0 m
 9,6 m
CHÃO C/ ABAS 206cm

REF.: VAR0224

NCM
 7615.10.00

 139 cm
 186 cm
 206 cm

 9,0 kg
 13,0 kg
 15,0 kg

 11,5 m
 15,0 m
 16,5 m
PRODUTO

VARAL DE ALUMÍNIO	REFERÊNCIA	GTIN 13	PESO LÍQUIDO	TAMANHO ABERTO (LxCxA)
DE CHÃO 0,80 x 0,56m	VAR0595	790815540331-4	1,39 (kg)	56,0 x 79,0 x 85,0 (cm)
DE CHÃO 1,00 x 0,56m	VAR0221	790815540332-1	1,52 (kg)	56,0 x 99,0 x 85,0 (cm)
DE CHÃO 1,20 x 0,56m	VAR0222	790815540333-8	1,73 (kg)	56,0 x 119,0 x 87,0 (cm)
DE CHÃO C/ ABAS 1,39 x 0,56m	VAR0655	790815540334-5	1,87 (kg)	56,0 x 79,0 x 80,0 (cm)
DE CHÃO C/ ABAS 1,86 x 0,56m	VAR0223	790815540335-2	2,17 (kg)	56,0 x 99,0 x 85,0 (cm)
DE CHÃO C/ ABAS 2,06 x 0,56m	VAR0224	790815540336-9	2,39 (kg)	56,0 x 119,0 x 86,0 (cm)

EMBALAGEM

EMBALAGEM	TAMANHO (LxCxA)	VOLUME	PESO BRUTO
05	56,0 x 116,0 x 20,0 (cm)	0,129 m³	8,97 (kg)
05	56,0 x 127,5 x 20,0 (cm)	0,142 m³	9,78 (kg)
05	56,0 x 141,5 x 20,0 (cm)	0,158 m³	11,06 (kg)
05	56,0 x 111,0 x 30,0 (cm)	0,186 m³	11,82 (kg)
05	56,0 x 128,5 x 30,0 (cm)	0,215 m³	13,77 (kg)
05	56,0 x 142,0 x 30,0 (cm)	0,238 m³	15,27 (kg)

NCM
7615.10.00

80 cm	4,5 kg	6,4 m
100 cm	5,0 kg	8,0 m
120 cm	8,2 kg	9,6 m
140 cm	9,0 kg	11,5 m



NCM
7615.10.00

60 cm	3,5 kg	5,0 m
80 cm	4,0 kg	6,5 m
100 cm	4,5 kg	8,0 m

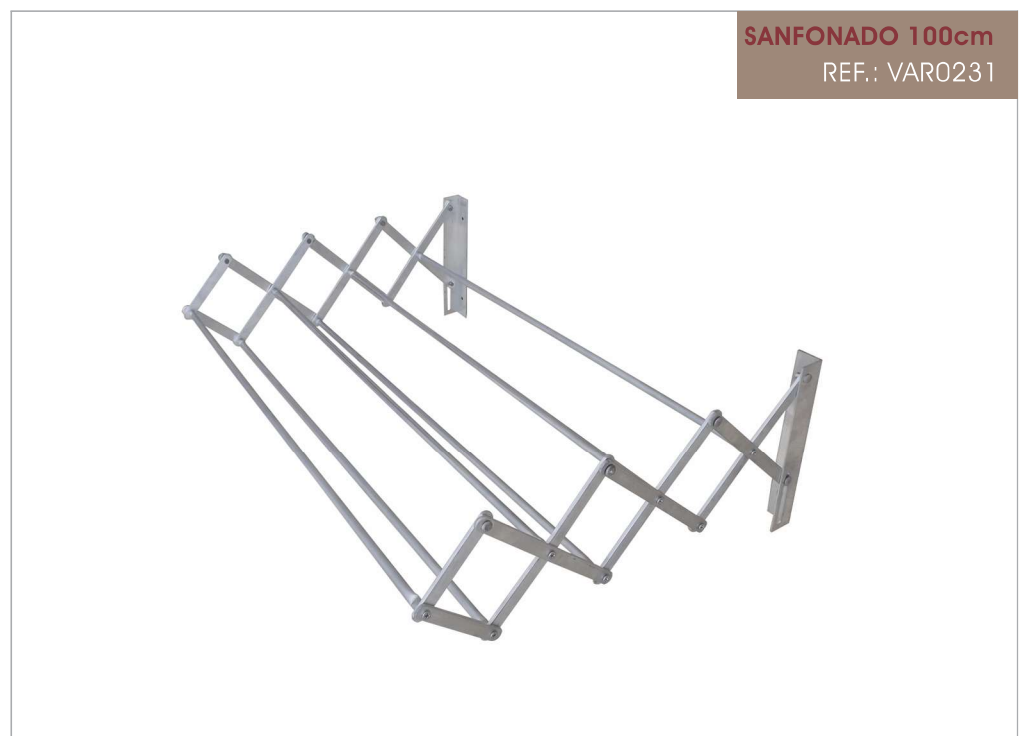

PRODUTO					EMBALAGEM			
VARAL DE ALUMÍNIO	REFERÊNCIA	GTIN 13	PESO LÍQUIDO	TAMANHO ABERTO (LxCxA)	EMBALAGEM	TAMANHO (LxCxA)	VOLUME	PESO BRUTO
DE TETO 0,80 x 0,56m	VAR0225	790815540337-6	0,78 (kg)	56,0 x 79,0 x 2,0 (cm)	05	56,0 x 79,0 x 10,0 (cm)	0,044 m³	5,28 (kg)
DE TETO 1,00 x 0,56m	VAR0226	790815540338-3	0,90 (kg)	56,0 x 99,0 x 2,0 (cm)	05	56,0 x 99,0 x 10,0 (cm)	0,055 m³	6,03 (kg)
DE TETO 1,20 x 0,56m	VAR0227	790815540339-0	1,02 (kg)	56,0 x 119,0 x 2,0 (cm)	05	56,0 x 119,0 x 10,0 (cm)	0,066 m³	6,93 (kg)
DE TETO 1,40 x 0,56m	VAR0228	790815540340-6	1,11 (kg)	56,0 x 139,0 x 2,0 (cm)	05	56,0 x 139,0 x 10,0 (cm)	0,077 m³	7,53 (kg)
SANFONADO 0,60m	VAR0229	790815540341-3	0,60 (kg)	56,0 x 62,0 x 18,6 (cm)	06	56,0 x 62,0 x 20,0 (cm)	0,063 m³	3,69 (kg)
SANFONADO 0,80m	VAR0230	790815540342-0	0,69 (kg)	56,0 x 81,0 x 18,6 (cm)	06	56,0 x 82,0 x 20,0 (cm)	0,084 m³	4,32 (kg)
SANFONADO 1,00m	VAR0231	790815540343-7	0,77 (kg)	56,0 x 100,5 x 18,6 (cm)	06	56,0 x 101,0 x 20,0 (cm)	0,104 m³	4,80 (kg)

2,5m REFORÇADA
 REF.: REG0600



NCM
 7616.99.00



ESTRUTURA REFORÇADA

RODO DE ALUMÍNIO

RODO 60 cm
 REF.: ROD0204



NCM
 7616.99.00



REFIS PARA TODOS OS TAMANHOS

PRODUTO

RÉGUA DE PEDREIRO	REFERÊNCIA	GTIN 13	PESO LÍQUIDO	TAMANHO (LxCxA)
1,50m	REG0594	790815540613-1	0,46 (kg)	5,0 x 2,5 x 150,0 (cm)
2,00m	REG0595	790815540614-8	0,59 (kg)	5,0 x 2,5 x 200,0 (cm)
2,50m	REG0596	790815540615-5	0,73 (kg)	5,0 x 2,5 x 250,0 (cm)
3,00m	REG0597	790815540616-2	0,86 (kg)	5,0 x 2,5 x 300,0 (cm)
1,50m REFORÇADA	REG0598	790815540323-9	0,52 (kg)	5,0 x 2,5 x 150,0 (cm)
2,00m REFORÇADA	REG0599	790815540324-6	0,72 (kg)	5,0 x 2,5 x 200,0 (cm)
2,50m REFORÇADA	REG0600	790815540325-3	0,85 (kg)	5,0 x 2,5 x 250,0 (cm)
3,00m REFORÇADA	REG0601	790815540326-0	1,07 (kg)	5,0 x 2,5 x 300,0 (cm)

EMBALAGEM

EMBALAGEM	TAMANHO (LxCxA)	VOLUME	PESO BRUTO
06	5,1 x 2,6 x 150,1 (cm)	0,002 m³	2,90 (kg)
06	5,1 x 2,6 x 200,1 (cm)	0,003 m³	3,68 (kg)
06	5,1 x 2,6 x 250,1 (cm)	0,003 m³	4,52 (kg)
06	5,1 x 2,6 x 300,1 (cm)	0,004 m³	5,27 (kg)
06	5,1 x 2,6 x 150,1 (cm)	0,002 m³	3,23 (kg)
06	5,1 x 2,6 x 200,1 (cm)	0,003 m³	4,43 (kg)
06	5,1 x 2,6 x 250,1 (cm)	0,003 m³	5,21 (kg)
06	5,1 x 2,6 x 300,1 (cm)	0,004 m³	6,53 (kg)

RODOS DE ALUMÍNIO	REFERÊNCIA	GTIN 13	PESO LÍQUIDO	TAMANHO FECHADO (LxCxA)
DE PIA 15cm	ROD0206	790815540344-4	0,17 (kg)	5,5 x 18,0 x 24,5 (cm)
30cm	ROD0202	790815540345-1	0,42 (kg)	7,5 x 11,0 x 122,0 (cm)
40cm	ROD0203	790815540346-8	0,45 (kg)	7,5 x 11,0 x 122,0 (cm)
60cm	ROD0204	790815540347-5	0,54 (kg)	7,5 x 11,0 x 122,0 (cm)
80cm	ROD0205	790815540348-2	0,68 (kg)	7,5 x 11,0 x 122,0 (cm)
100cm	ROD0208	790815540349-9	0,78 (kg)	7,5 x 11,0 x 122,0 (cm)

EMBALAGEM	TAMANHO (LxCxA)	VOLUME	PESO BRUTO
01	5,5 x 18,0 x 24,5 (cm)	0,002 m³	0,18 (kg)
10	14,0 x 18,0 x 124,0 (cm)	0,03 m³	4,70 (kg)
10	14,0 x 18,0 x 124,0 (cm)	0,03 m³	5,05 (kg)
10	14,0 x 18,0 x 124,0 (cm)	0,03 m³	6,04 (kg)
10	14,0 x 18,0 x 124,0 (cm)	0,03 m³	7,41 (kg)
10	14,0 x 18,0 x 124,0 (cm)	0,03 m³	8,32 (kg)

NCM
8716.80.00



55 LITROS
REF.: CAR0559



NCM
8716.80.00



65 LITROS
REF.: CAR0560



PRODUTO					EMBALAGEM			
CARRINHO DE MÃO	REFERÊNCIA	GTIN 13	PESO LÍQUIDO	TAMANHO ABERTO (LxCxA)	EMBALAGEM	TAMANHO (LxCxA)	VOLUME	PESO BRUTO
AÇO GALVANIZADO 55 L	CAR0559	790815540314-7	7,48 (kg)	49,0 x 148,0 x 50,0 (cm)	05			37,5 (kg)
AÇO GALVANIZADO 65 L	CAR0560	---	8,20 (kg)	49,0 x 148,0 x 55,0 (cm)	05			44,5 (kg)
KIT RODA CARRINHO DE MÃO	REFERÊNCIA	GTIN 13	PESO LÍQUIDO	TAMANHO FECHADO (LxCxA)	EMBALAGEM	TAMANHO (LxCxA)	VOLUME	PESO BRUTO
COMPLETO	KIT0561	790815540315-4	1,71 (kg)	9,2 x 36,0 x 36,0 (cm)	05	36,0 x 36,0 x 45,6 (cm)	0,059 m ³	8,79 (kg)

(KIT)
PÉS ESCADAS
DOMÉSTICAS
REF.: KIT0317



(KIT)
ACABAMENTOS
ESCADAS
DOMÉSTICAS
REF.: KIT0320



NCM
3926.90.69

(KIT)
ESCADAS PROFISSIONAIS
Articuladas
Extensivas P. Traseiro
REF.: KIT0571



(KIT) ESCADAS
PROFISSIONAIS
Paralelas
Extensivas P. Dianteiro
REF.: KIT0675



KIT P/ VARAL
REF.: KIT4147



KIT PISCINA
REF.: KIT0400

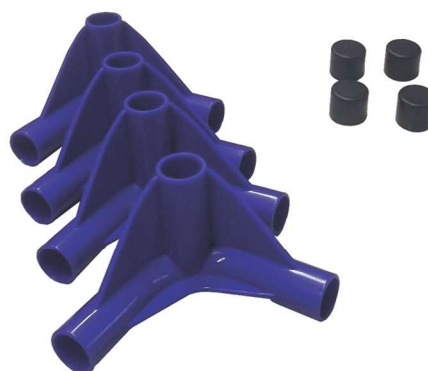

(RODAS) ESCADAS
EXTENSIVAS
DE ALUMÍNIO
REF.: KIT0679



PRODUTO					EMBALAGEM			
KIT	REFERÊNCIA	GTIN 13	PESO LÍQUIDO	TAMANHO FECHADO (LxCxA)	EMBALAGEM	TAMANHO (LxCxA)	VOLUME	PESO BRUTO
PÉS P/ ESCADAS DOMÉSTICAS.	KIT0317	790815540430-4	0,05 (kg)	7,0 x 12,0 x 2,5 (cm)	05	13,0 x 20,0 x 18,5 (cm)	0,004 m³	0,36 (kg)
ACABAMENTOS P/ ESCADAS DOMES.	KIT0320	790815540432-8	0,01 (kg)	12,0 x 16,0 x 2,5 (cm)	05	13,5 x 20,5 x 11,5 (cm)	0,003 m³	0,23 (kg)
PÉS EXTERNOS P/ ESCADAS PROF.	KIT0571	790815540426-7	0,13 (kg)	9,0 x 16,0 x 3,0 (cm)	05	14,0 x 13,5 x 18,5 (cm)	0,002 m³	0,38 (kg)
PÉS INTERNOS P/ ESCADAS PROF.	KIT0675	780815540453-3	0,05 (kg)	10,5 x 8,5 x 2,5 (cm)	05	14,5 x 18,0 x 8,5 (cm)	0,003 m³	0,81 (kg)
CORDAS P/ VARAIS DE TETO	KIT4147	780815540435-9	0,10 (kg)	11,5 x 22,0 x 3,0 (cm)	10	13,0 x 20,0 x 18,0 (cm)	0,004 m³	1,26 (kg)
RODAS P/ ESCADAS EXTENSIVAS	KIT0679	780815540427-4	0,17 (kg)	14,0 x 28,0 x 4,0 (cm)	05	15,0 x 24,0 x 26,5 (cm)	0,009 m³	1,13 (kg)
REPOSIÇÃO PISCINA 400L	KIT0400	780815540653-7	0,14 (kg)	13,0 x 20,0 x 18,0 (cm)	01	13,2 x 20,2 x 18,2 (cm)	0,004 m³	0,22 (kg)
REPOSIÇÃO PISCINA 1000L	KIT1000	780815540654-4	0,29 (kg)	13,0 x 20,0 x 18,0 (cm)	01	13,2 x 20,2 x 18,2 (cm)	0,004 m³	0,37 (kg)
REPOSIÇÃO PISCINA 1500L	KIT1500	780815540655-1	0,34 (kg)	13,0 x 20,0 x 18,0 (cm)	01	13,2 x 20,2 x 18,2 (cm)	0,004 m³	0,41 (kg)
REPOSIÇÃO PISCINA 2000L	KIT2000	780815540656-8	0,66 (kg)	15,0 x 24,0 x 26,0 (cm)	01	15,2 x 24,2 x 27,0 (cm)	0,009 m³	0,78 (kg)
REPOSIÇÃO PISCINA 3000L	KIT3000	780815540657-5	0,84 (kg)	15,0 x 24,0 x 26,0 (cm)	01	15,2 x 24,2 x 27,0 (cm)	0,009 m³	0,95 (kg)

Indicado para até
100kg

NCM
9401.79.00



RECLINÁVEL EM 4 POSIÇÕES



8 OPÇÕES DE CORES



ALÇA PARA TRANSPORTE

AZUL ROYAL
REF.: CAD0711

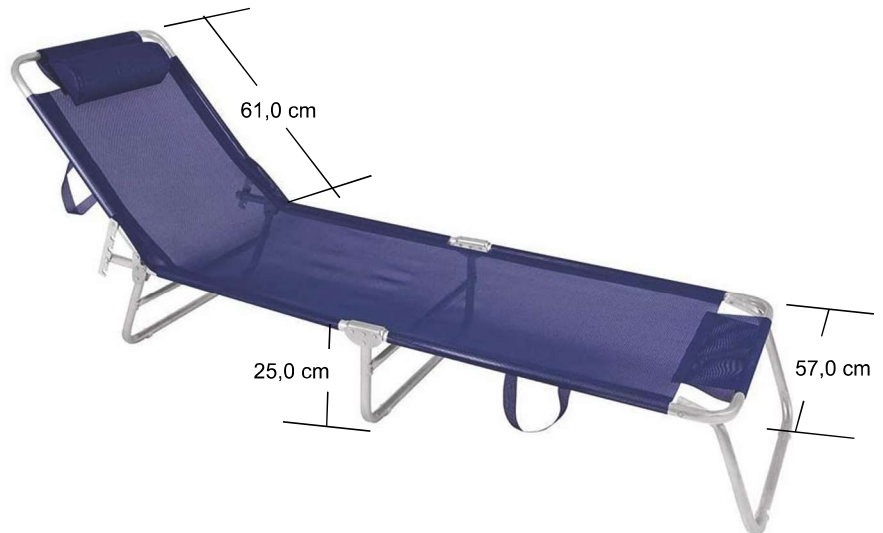

PRODUTO					EMBALAGEM			
ESPREGUIÇADEIRA	REFERÊNCIA	GTIN 13	PESO LÍQUIDO	TAMANHO FECHADO (LxCxA)	EMBALAGEM	TAMANHO (LxCxA)	VOLUME	PESO BRUTO
AZUL ROYAL	CAD0711	790815540546-2	2,70 (kg)	57,0 x 13,0 x 72,5 (cm)	01	57,5 x 16,0 x 73,5 (cm)	0,067 m³	3,10 (kg)
ROXA	CAD0712	790815540547-9	2,70 (kg)	57,0 x 13,0 x 72,5 (cm)	01	57,5 x 16,0 x 73,5 (cm)	0,067 m³	3,10 (kg)
VERDE PRIMAVERA	CAD0713	790815540548-6	2,70 (kg)	57,0 x 13,0 x 72,5 (cm)	01	57,5 x 16,0 x 73,5 (cm)	0,067 m³	3,10 (kg)
LARANJA	CAD0714	790815540549-3	2,70 (kg)	57,0 x 13,0 x 72,5 (cm)	01	57,5 x 16,0 x 73,5 (cm)	0,067 m³	3,10 (kg)
AMARELA	CAD0715	790815540550-9	2,70 (kg)	57,0 x 13,0 x 72,5 (cm)	01	57,5 x 16,0 x 73,5 (cm)	0,067 m³	3,10 (kg)
ROSA	CAD0716	790815540551-6	2,70 (kg)	57,0 x 13,0 x 72,5 (cm)	01	57,5 x 16,0 x 73,5 (cm)	0,067 m³	3,10 (kg)
VERMELHA	CAD0717	790815540552-3	2,70 (kg)	57,0 x 13,0 x 72,5 (cm)	01	57,5 x 16,0 x 73,5 (cm)	0,067 m³	3,10 (kg)
PRETA	CAD0718	790815540553-0	2,70 (kg)	57,0 x 13,0 x 72,5 (cm)	01	57,5 x 16,0 x 73,5 (cm)	0,067 m³	3,10 (kg)

**COPACABANA
VERMELHA**

REF.: CAD0360

Indicado para até
120kg**NCM**
9401.79.00

RECLINÁVEL EM 5 POSIÇÕES



8 OPÇÕES DE CORES

**VARANDA EL
ROXA**

REF.: CAD0412

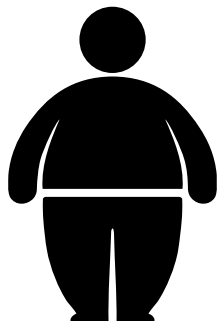
Indicado para até
130kgIndicado para até
130kg**NCM**
9401.79.00

BRAÇOS EM ALUMÍNIO



8 OPÇÕES DE CORES

PRODUTO					EMBALAGEM			
CADEIRA DE PRAIA	REFERÊNCIA	GTIN 13	PESO LÍQUIDO	TAMANHO FECHADO (LxCxA)	EMBALAGEM	TAMANHO (LxCxA)	VOLUME	PESO BRUTO
COPACABANA - AMARELA	CAD0401	790815540216-4	2,78 (kg)	57,0 x 10,0 x 86,0 (cm)	05	58,0 x 53,0 x 87,0 (cm)	0,267 m³	15,54 (kg)
COPACABANA - LARANJA	CAD0400	790815540217-1	2,78 (kg)	57,0 x 10,0 x 86,0 (cm)	05	58,0 x 53,0 x 87,0 (cm)	0,267 m³	15,54 (kg)
COPACABANA - AZUL ROYAL	CAD0399	790815540218-8	2,78 (kg)	57,0 x 10,0 x 86,0 (cm)	05	58,0 x 53,0 x 87,0 (cm)	0,267 m³	15,54 (kg)
COPACABANA - VERDE P.	CAD0316	790815540219-5	2,78 (kg)	57,0 x 10,0 x 86,0 (cm)	05	58,0 x 53,0 x 87,0 (cm)	0,267 m³	15,54 (kg)
COPACABANA - ROXA	CAD0398	790815540220-1	2,78 (kg)	57,0 x 10,0 x 86,0 (cm)	05	58,0 x 53,0 x 87,0 (cm)	0,267 m³	15,54 (kg)
COPACABANA - ROSA	CAD0683	790815540221-8	2,78 (kg)	57,0 x 10,0 x 86,0 (cm)	05	58,0 x 53,0 x 87,0 (cm)	0,267 m³	15,54 (kg)
COPACABANA - VERMELHA	CAD0360	790815540499-1	2,78 (kg)	57,0 x 10,0 x 86,0 (cm)	05	58,0 x 53,0 x 87,0 (cm)	0,267 m³	15,54 (kg)
COPACABANA - PRETA	CAD0365	790815540542-4	2,78 (kg)	57,0 x 10,0 x 86,0 (cm)	05	58,0 x 53,0 x 87,0 (cm)	0,267 m³	15,54 (kg)
VARANDA EL - AMARELA	CAD0408	790815540195-2	2,45 (kg)	63,5 x 10,0 x 80,5 (cm)	05	64,0 x 46,0 x 81,0 (cm)	0,238 m³	13,55 (kg)
VARANDA EL - LARANJA	CAD0409	790815540196-9	2,45 (kg)	63,5 x 10,0 x 80,5 (cm)	05	64,0 x 46,0 x 81,0 (cm)	0,238 m³	13,55 (kg)
VARANDA EL - AZUL ROYAL	CAD0410	790815540197-6	2,45 (kg)	63,5 x 10,0 x 80,5 (cm)	05	64,0 x 46,0 x 81,0 (cm)	0,238 m³	13,55 (kg)
VARANDA EL - VERDE P.	CAD0411	790815540198-3	2,45 (kg)	63,5 x 10,0 x 80,5 (cm)	05	64,0 x 46,0 x 81,0 (cm)	0,238 m³	13,55 (kg)
VARANDA EL - ROXA	CAD0412	790815540199-0	2,45 (kg)	63,5 x 10,0 x 80,5 (cm)	05	64,0 x 46,0 x 81,0 (cm)	0,238 m³	13,55 (kg)
VARANDA EL - ROSA	CAD0680	790815540200-3	2,45 (kg)	63,5 x 10,0 x 80,5 (cm)	05	64,0 x 46,0 x 81,0 (cm)	0,238 m³	13,55 (kg)
VARANDA EL - VERMELHA	CAD0450	790815540500-4	2,45 (kg)	63,5 x 10,0 x 80,5 (cm)	05	64,0 x 46,0 x 81,0 (cm)	0,238 m³	13,55 (kg)
VARANDA EL - PRETA	CAD0675	790815540537-0	2,45 (kg)	63,5 x 10,0 x 80,5 (cm)	05	64,0 x 46,0 x 81,0 (cm)	0,238 m³	13,55 (kg)

Indicado para até
120kg

NCM
9401.79.00



Indicado para até
120kg

NCM
9401.79.00



PRODUTO					EMBALAGEM			
CADEIRA DE PRAIA	REFERÊNCIA	GTIN 13	PESO LÍQUIDO	TAMANHO FECHADO (LxCxA)	EMBALAGEM	TAMANHO (LxCxA)	VOLUME	PESO BRUTO
IPANEMA - AMARELA	CAD0397	790815540202-7	2,70 (kg)	58,0 x 9,5 x 82,5 (cm)	05	58,5 x 38,0 x 84,0 (cm)	0,187 m³	14,72 (kg)
IPANEMA - AZUL ROYAL	CAD0328	790815540204-1	2,70 (kg)	58,0 x 9,5 x 82,5 (cm)	05	58,5 x 38,0 x 84,0 (cm)	0,187 m³	14,72 (kg)
IPANEMA - LARANJA	CAD0396	790815540203-4	2,70 (kg)	58,0 x 9,5 x 82,5 (cm)	05	58,5 x 38,0 x 84,0 (cm)	0,187 m³	14,72 (kg)
IPANEMA - ROXA	CAD0394	790815540206-5	2,70 (kg)	58,0 x 9,5 x 82,5 (cm)	05	58,5 x 38,0 x 84,0 (cm)	0,187 m³	14,72 (kg)
IPANEMA - VERDE PRIM.	CAD0395	790815540205-8	2,70 (kg)	58,0 x 9,5 x 82,5 (cm)	05	58,5 x 38,0 x 84,0 (cm)	0,187 m³	14,72 (kg)
IPANEMA - VERMELHA	CAD0686	790815540497-7	2,70 (kg)	58,0 x 9,5 x 82,5 (cm)	05	58,5 x 38,0 x 84,0 (cm)	0,187 m³	14,72 (kg)
IPANEMA - PRETA	CAD0690	790815540543-1	2,70 (kg)	58,0 x 9,5 x 82,5 (cm)	05	58,5 x 38,0 x 84,0 (cm)	0,187 m³	14,72 (kg)
IPANEMA - ROSA	CAD0684	790815540207-2	2,70 (kg)	58,0 x 9,5 x 82,5 (cm)	05	58,5 x 38,0 x 84,0 (cm)	0,187 m³	14,72 (kg)
GR. IPANEMA - AMARELA	CAD0664	790815540209-6	2,73 (kg)	58,0 x 9,5 x 92,0 (cm)	05	58,5 x 40,0 x 93,0 (cm)	0,214 m³	14,93 (kg)
GR. IPANEMA - AZUL ROYAL	CAD0666	790815540211-9	2,73 (kg)	58,0 x 9,5 x 92,0 (cm)	05	58,5 x 40,0 x 93,0 (cm)	0,214 m³	14,93 (kg)
GR. IPANEMA - LARANJA	CAD0665	790815540210-2	2,73 (kg)	58,0 x 9,5 x 92,0 (cm)	05	58,5 x 40,0 x 93,0 (cm)	0,214 m³	14,93 (kg)
GR. IPANEMA - ROXA	CAD0668	790815540213-3	2,73 (kg)	58,0 x 9,5 x 92,0 (cm)	05	58,5 x 40,0 x 93,0 (cm)	0,214 m³	14,93 (kg)
GR. IPANEMA - VERDE PRIM.	CAD0667	790815540212-6	2,73 (kg)	58,0 x 9,5 x 92,0 (cm)	05	58,5 x 40,0 x 93,0 (cm)	0,214 m³	14,93 (kg)
GR. IPANEMA - VERMELHA	CAD0670	790815540498-4	2,73 (kg)	58,0 x 9,5 x 92,0 (cm)	05	58,5 x 40,0 x 93,0 (cm)	0,214 m³	14,93 (kg)
GR. IPANEMA - PRETA	CAD0672	790815540544-8	2,73 (kg)	58,0 x 9,5 x 92,0 (cm)	05	58,5 x 40,0 x 93,0 (cm)	0,214 m³	14,93 (kg)
GR. IPANEMA - ROSA	CAD0685	790815540214-0	2,73 (kg)	58,0 x 9,5 x 92,0 (cm)	05	58,5 x 40,0 x 93,0 (cm)	0,214 m³	14,93 (kg)

**BANQUETA
PESCADOR**
 REF.: CAD0018

NCM
 9401.79.00

CORES SORTIDAS

**VARANDA
ALTA**
 REF.: CAD0047

CORES SORTIDAS



 BRAÇOS EM POLÍMERO
 DE ALTA RESISTÊNCIA

**VARANDA ALTA
INFANTIL**
 REF.: CAD0032

CORES SORTIDAS

PRODUTO					EMBALAGEM			
CADEIRA DE PRAIA	REFERÊNCIA	GTIN 13	PESO LÍQUIDO	TAMANHO FECHADO (LxCxA)	EMBALAGEM	TAMANHO (LxCxA)	VOLUME	PESO BRUTO
BANQUETA PESCADOR	CAD0018	790815540188-4	0,52 (kg)	26,5 x 5,0 x 54,5 (cm)	10	35,0 x 25,0 x 64,0 (cm)	0,056 m ³	5,33 (kg)
VARANDA ALTA	CAD0047	790815540194-5	1,26 (kg)	54,0 x 7,5 x 66,0 (cm)	10	63,0 x 68,0 x 68,0 (cm)	0,291 m ³	13,54 (kg)
VARANDA INFANTIL	CAD0032	790815540189-1	0,83 (kg)	39,0 x 7,0 x 52,0 (cm)	10	41,5 x 45,5 x 55,5 (cm)	0,105 m ³	8,95 (kg)

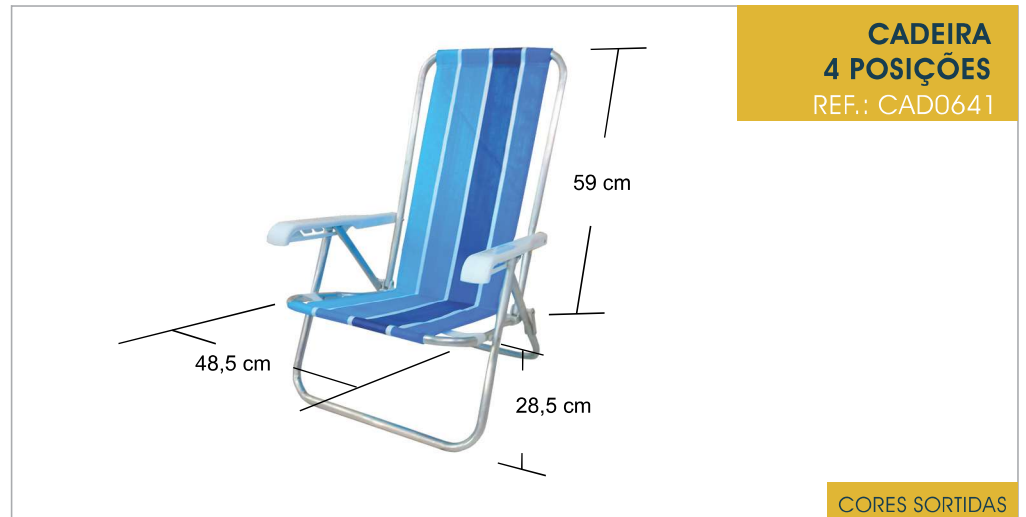
NCM
9401.79.00



PRODUTO					EMBALAGEM			
CADEIRA DE PRAIA	REFERÊNCIA	GTIN 13	PESO LÍQUIDO	TAMANHO FECHADO (LxCxA)	EMBALAGEM	TAMANHO (LxCxA)	VOLUME	PESO BRUTO
2 POSIÇÕES	CAD0041	790815540190-7	1,45 (kg)	52,0 x 6,0 x 73,0 (cm)	10	54,0 x 54,0 x 75,5 (cm)	0,220 m ³	15,52 (kg)
4 POSIÇÕES	CAD0641	790815540191-4	1,59 (kg)	56,0 x 9,5 x 79,0 (cm)	05	57,0 x 38,5 x 80,5 (cm)	0,177 m ³	8,90 (kg)
5 POSIÇÕES	CAD0039	790815540192-1	1,65 (kg)	58,5 x 8,0 x 81,0 (cm)	05	61,0 x 28,0 x 82,0 (cm)	0,140 m ³	9,19 (kg)

2.000 litros
REF.: PIS0630

NCM
9506.90.00

MEDIDAS (m)

400 Litros	1,15 x 1,06 x 0,33
1.000 Litros	1,89 x 1,26 x 0,42
1.500 Litros	1,89 x 1,89 x 0,42
2.000 Litros	2,11 x 1,64 x 0,58
3.000 Litros	3,20 x 1,64 x 0,58

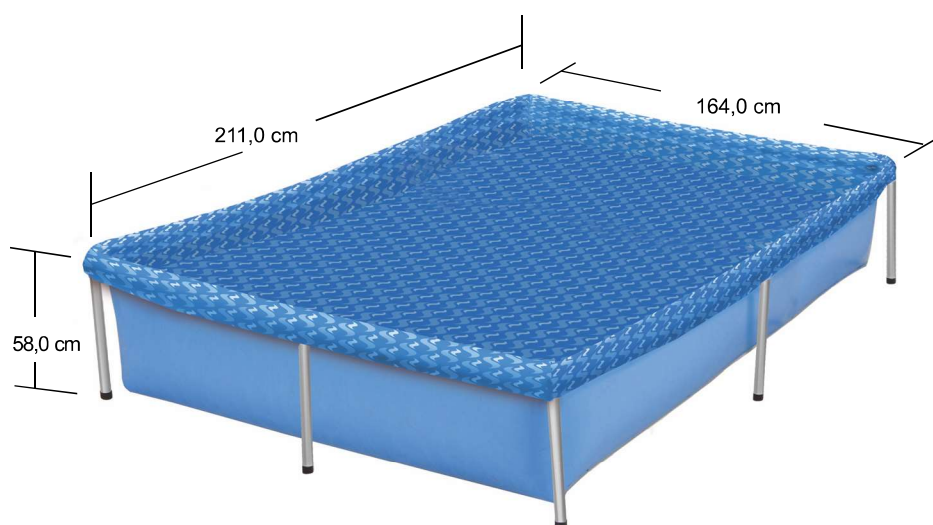

PRODUZIDO NO BRASIL



PRODUTO					EMBALAGEM			
PISCINA ESTRUTURADA	REFERÊNCIA	GTIN 13	PESO LÍQUIDO	TAMANHO ABERTO (LxCxA)	EMBALAGEM	TAMANHO (LxCxA)	VOLUME	PESO BRUTO
400 L	PIS0627	790815540175-4	3,30 (kg)	115,0 x 106,0 x 33,0 (cm)	01	15,5 x 58,7 x 11,0 (cm)	0,010 m ³	3,55 (kg)
1.000 L	PIS0628	790815540176-1	6,20 (kg)	189,0 x 126,0 x 42,0 (cm)	01	20,5 x 66,5 x 11,5 (cm)	0,015 m ³	6,50 (kg)
1.500 L	PIS0629	790815540177-8	7,77 (kg)	189,0 x 189,0 x 42,0 (cm)	01	20,5 x 66,5 x 13,8 (cm)	0,018 m ³	8,17 (kg)
2.000 L	PIS0630	790815540178-5	10,22 (kg)	211,0 x 164,0 x 58,0 (cm)	01	24,0 x 80,3 x 17,5 (cm)	0,033 m ³	11,02 (kg)
3.000 L	PIS0631	790815540179-2	16,09 (kg)	320,0 x 164,0 x 58,0 (cm)	01	28,0 x 84,5 x 20,0 (cm)	0,047 m ³	16,45 (kg)

NCM
8716.80.00



REF.: CAR0659

REF.: CAR0649



REF.: CAR0659



REF.: CAR0660



Indicado para até
6 CADEIRAS

NCM
7616.99.00

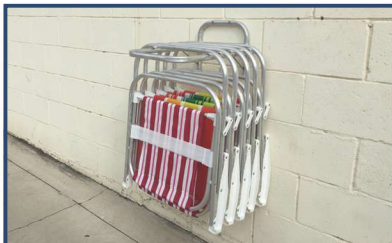

REF.: SUPO673

PRODUTO					EMBALAGEM			
CARRINHO MESA DE PRAIA	REFERÊNCIA	GTIN 13	PESO LÍQUIDO	TAMANHO ABERTO (LxCxA)	EMBALAGEM	TAMANHO (LxCxA)	VOLUME	PESO BRUTO
MULTIUSO EM ALUMÍNIO	CAR0649	790815540185-3	2,86 (kg)	49,5 x 110,0 x 44,0 (cm)	04	51,0 x 108,0 x 44,0 (cm)	0,242 m³	13,71 (kg)
MULTIUSO COM ACESSÓRIOS	CAR0659	790815540186-0	2,87 (kg)	49,5 x 110,0 x 44,0 (cm)	04	51,0 x 108,0 x 44,0 (cm)	0,242 m³	13,75 (kg)
MULTIUSO C/ AVANÇO / EXTENSÃO	CAR0660	790815540187-7	3,06 (kg)	49,5 x 110,0 x 44,0 (cm)	04	51,0 x 108,0 x 44,0 (cm)	0,242 m³	14,23 (kg)
SUPOORTE CADEIRA DE PRAIA	REFERÊNCIA	GTIN 13	PESO LÍQUIDO	TAMANHO ABERTO (LxCxA)	EMBALAGEM	TAMANHO (LxCxA)	VOLUME	PESO BRUTO
SUPOORTE DE PAREDE	SUP0673	790815540322-2	0,39 (kg)	37,0 x 43,2 x 21,0 (cm)	06	39,0 x 58,5 x 15,0 (cm)	0,034 m³	2,74 (kg)

AMARELO 1,80 m
REF.: GSL0437



**FPS
100**

**NCM
6601.91.10**

TAMANHOS (Ø)

1,40 m
1,60 m
1,80 m
2,00 m
2,20 m

HASTE

alumínio
madeira



5 OPÇÕES DE CORES



TAMANHOS

70 cm
80 cm
100 cm



5 OPÇÕES DE CORES



PRODUTO						EMBALAGEM			
GUARDA-SOL	HASTE ALUMÍNIO	REFERÊNCIA	GTIN 13	PESO LÍQUIDO	TAMANHO ABERTO (LxCxA)	EMBALAGEM	TAMANHO (LxCxA)	VOLUME	PESO BRUTO
70x8 PVC - AMARELO		GSL0413	790815540000-9	1,48 (kg)	140,0 x 140,0 x 160,0 (cm)	20	12,5 x 38,0 x 102,0 (cm)	0,048 m³	30,94 (kg)
70x8 PVC - LARANJA		GSL0414	790815540001-6	1,48 (kg)	140,0 x 140,0 x 160,0 (cm)	20	12,5 x 38,0 x 102,0 (cm)	0,048 m³	30,94 (kg)
70x8 PVC - AZUL ROYAL		GSL0415	790815540002-3	1,48 (kg)	140,0 x 140,0 x 160,0 (cm)	20	12,5 x 38,0 x 102,0 (cm)	0,048 m³	30,94 (kg)
70x8 PVC - VERDE PRIM.		GSL0417	790815540003-0	1,48 (kg)	140,0 x 140,0 x 160,0 (cm)	20	12,5 x 38,0 x 102,0 (cm)	0,048 m³	30,94 (kg)
70x8 PVC - ROXO		GSL0418	790815540005-4	1,48 (kg)	140,0 x 140,0 x 160,0 (cm)	10	12,5 x 38,0 x 102,0 (cm)	0,048 m³	30,94 (kg)
80x8 PVC - AMARELO		GSL0425	790815540016-0	2,04 (kg)	160,0 x 160,0 x 190,0 (cm)	10	16,0 x 41,0 x 108,0 (cm)	0,070 m³	21,79 (kg)
80x8 PVC - LARANJA		GSL0426	790815540017-7	2,04 (kg)	160,0 x 160,0 x 190,0 (cm)	10	16,0 x 41,0 x 108,0 (cm)	0,070 m³	21,79 (kg)
80x8 PVC - AZUL ROYAL		GSL0427	790815540018-4	2,04 (kg)	160,0 x 160,0 x 190,0 (cm)	10	16,0 x 41,0 x 108,0 (cm)	0,070 m³	21,79 (kg)
80x8 PVC - VERDE PRIM.		GSL0429	790815540019-1	2,04 (kg)	160,0 x 160,0 x 190,0 (cm)	10	16,0 x 41,0 x 108,0 (cm)	0,070 m³	21,79 (kg)
80x8 PVC - ROXO		GSL0430	790815540021-4	2,04 (kg)	160,0 x 160,0 x 190,0 (cm)	10	16,0 x 41,0 x 108,0 (cm)	0,070 m³	21,79 (kg)
90x8 PVC - AMARELO		GSL0437	790815540034-4	2,37 (kg)	180,0 x 180,0 x 200,0 (cm)	10	23,5 x 31,5 x 113,5 (cm)	0,084 m³	24,81 (kg)
90x8 PVC - LARANJA		GSL0438	790815540035-1	2,37 (kg)	180,0 x 180,0 x 200,0 (cm)	10	23,5 x 31,5 x 113,5 (cm)	0,084 m³	24,81 (kg)
90x8 PVC - AZUL ROYAL		GSL0439	790815540036-8	2,37 (kg)	180,0 x 180,0 x 200,0 (cm)	10	23,5 x 31,5 x 113,5 (cm)	0,084 m³	24,81 (kg)
90x8 PVC - VERDE PRIM.		GSL0441	790815540038-2	2,37 (kg)	180,0 x 180,0 x 200,0 (cm)	10	23,5 x 31,5 x 113,5 (cm)	0,084 m³	24,81 (kg)
90x8 PVC - ROXO		GSL0442	790815540039-9	2,37 (kg)	180,0 x 180,0 x 200,0 (cm)	10	23,5 x 31,5 x 113,5 (cm)	0,084 m³	24,81 (kg)
100x8 PVC - AMARELO		GSL0449	790815540050-4	2,88 (kg)	200,0 x 200,0 x 210,0 (cm)	10	25,0 x 32,5 x 122,0 (cm)	0,099 m³	30,16 (kg)
100x8 PVC - LARANJA		GSL0450	790815540051-1	2,88 (kg)	200,0 x 200,0 x 210,0 (cm)	10	25,0 x 32,5 x 122,0 (cm)	0,099 m³	30,16 (kg)
100x8 PVC - AZUL ROYAL		GSL0451	790815540052-8	2,88 (kg)	200,0 x 200,0 x 210,0 (cm)	10	25,0 x 32,5 x 122,0 (cm)	0,099 m³	30,16 (kg)
100x8 PVC - VERDE PRIM.		GSL0452	790815540054-2	2,88 (kg)	200,0 x 200,0 x 210,0 (cm)	10	25,0 x 32,5 x 122,0 (cm)	0,099 m³	30,16 (kg)
100x8 PVC - ROXO		GSL0454	790815540055-9	2,88 (kg)	200,0 x 200,0 x 210,0 (cm)	10	25,0 x 32,5 x 122,0 (cm)	0,099 m³	30,16 (kg)
110x8 PVC - VERDE PRIM.		GSL9938	789896319938-0	3,37 (kg)	210,0 x 210,0 x 240,0 (cm)	06	15,5 x 25,0 x 133,0 (cm)	0,051 m³	20,40 (kg)
110x8 PVC - AZUL ROYAL		GSL9939	789896319939-7	3,37 (kg)	210,0 x 210,0 x 240,0 (cm)	06	15,5 x 25,0 x 133,0 (cm)	0,051 m³	20,40 (kg)

PRODUTO						EMBALAGEM			
GUARDA-SOL	HASTE MADEIRA	REFERÊNCIA	GTIN 13	PESO LÍQUIDO	TAMANHO ABERTO (LxCxA)	EMBALAGEM	TAMANHO (LxCxA)	VOLUME	PESO BRUTO
70x8 PVC - AMARELO		GSL0419	790815540008-5	1,56 (kg)	140,0 x 140,0 x 182,0 (cm)	20	24,0 x 37,5 x 101,0 (cm)	0,090 m³	32,80 (kg)
70x8 PVC - LARANJA		GSL0420	790815540009-2	1,56 (kg)	140,0 x 140,0 x 182,0 (cm)	20	24,0 x 37,5 x 101,0 (cm)	0,090 m³	32,80 (kg)
70x8 PVC - AZUL ROYAL		GSL0421	790815540010-8	1,56 (kg)	140,0 x 140,0 x 182,0 (cm)	20	24,0 x 37,5 x 101,0 (cm)	0,090 m³	32,80 (kg)
70x8 PVC - VERDE PRIM.		GSL0423	790815540011-5	1,56 (kg)	140,0 x 140,0 x 182,0 (cm)	20	24,0 x 37,5 x 101,0 (cm)	0,090 m³	32,80 (kg)
70x8 PVC - ROXO		GSL0424	790815540013-9	1,56 (kg)	140,0 x 140,0 x 182,0 (cm)	20	24,0 x 37,5 x 101,0 (cm)	0,090 m³	32,80 (kg)
80x8 PVC - AMARELO		GSL0431	790815540025-2	2,63 (kg)	160,0 x 160,0 x 204,0 (cm)	10	15,5 x 38,5 x 107,0 (cm)	0,063 m³	27,25 (kg)
80x8 PVC - LARANJA		GSL0432	790815540026-9	2,63 (kg)	160,0 x 160,0 x 204,0 (cm)	10	15,5 x 38,5 x 107,0 (cm)	0,063 m³	27,25 (kg)
80x8 PVC - AZUL ROYAL		GSL0433	790815540027-6	2,63 (kg)	160,0 x 160,0 x 204,0 (cm)	10	15,5 x 38,5 x 107,0 (cm)	0,063 m³	27,25 (kg)
80x8 PVC - VERDE PRIM.		GSL0435	790815540029-0	2,63 (kg)	160,0 x 160,0 x 204,0 (cm)	10	15,5 x 38,5 x 107,0 (cm)	0,063 m³	27,25 (kg)
80x8 PVC - ROXO		GSL0436	790815540030-6	2,63 (kg)	160,0 x 160,0 x 204,0 (cm)	10	15,5 x 38,5 x 107,0 (cm)	0,063 m³	27,25 (kg)
90x8 PVC - AMARELO		GSL0443	790815540042-9	3,14 (kg)	180,0 x 180,0 x 213,0 (cm)	10	24,0 x 31,5 x 113,5 (cm)	0,085 m³	32,58 (kg)
90x8 PVC - LARANJA		GSL0444	790815540043-6	3,14 (kg)	180,0 x 180,0 x 213,0 (cm)	10	24,0 x 31,5 x 113,5 (cm)	0,085 m³	32,58 (kg)
90x8 PVC - AZUL ROYAL		GSL0445	790815540044-3	3,14 (kg)	180,0 x 180,0 x 213,0 (cm)	10	24,0 x 31,5 x 113,5 (cm)	0,085 m³	32,58 (kg)
90x8 PVC - VERDE PRIM.		GSL0447	790815540046-7	3,14 (kg)	180,0 x 180,0 x 213,0 (cm)	10	24,0 x 31,5 x 113,5 (cm)	0,085 m³	32,58 (kg)
90x8 PVC - ROXO		GSL0448	790815540047-4	3,14 (kg)	180,0 x 180,0 x 213,0 (cm)	10	24,0 x 31,5 x 113,5 (cm)	0,085 m³	32,58 (kg)
100x8 PVC - AMARELO		GSL0455	790815540058-0	3,45 (kg)	200,0 x 200,0 x 223,0 (cm)	10	23,0 x 31,0 x 121,0 (cm)	0,086 m³	35,86 (kg)
100x8 PVC - LARANJA		GSL0456	790815540059-7	3,45 (kg)	200,0 x 200,0 x 223,0 (cm)	10	23,0 x 31,0 x 121,0 (cm)	0,086 m³	35,86 (kg)
100x8 PVC - AZUL ROYAL		GSL0457	790815540060-3	3,45 (kg)	200,0 x 200,0 x 223,0 (cm)	10	23,0 x 31,0 x 121,0 (cm)	0,086 m³	35,86 (kg)
100x8 PVC - VERDE PRIM.		GSL0459	790815540061-0	3,45 (kg)	200,0 x 200,0 x 223,0 (cm)	10	23,0 x 31,0 x 121,0 (cm)	0,086 m³	35,86 (kg)
100x8 PVC - ROXO		GSL0460	790815540063-4	3,45 (kg)	200,0 x 200,0 x 223,0 (cm)	10	23,0 x 31,0 x 121,0 (cm)	0,086 m³	35,86 (kg)

PRODUTO					EMBALAGEM			
CAPA P/ GUARDA-SOL	REFERÊNCIA	GTIN 13	PESO LÍQUIDO	TAMANHO ABERTO (LxCxA)	EMBALAGEM	TAMANHO (LxCxA)	VOLUME	PESO BRUTO
70x8 (1.40m)	CAPA0700	7908155400087-0	0,10 (kg)	17,5 x 82,5 x 0,2 (cm)	10	29,5 x 39,0 x 8,0 (cm)	0,009 m³	1,12 (kg)
80x8 (1.60m)	CAPA0800	7908155400088-7	0,13 (kg)	18,0 x 98,0 x 0,2 (cm)	10	29,5 x 39,0 x 8,0 (cm)	0,009 m³	1,44 (kg)
100x8 (1.80m e 2.00m)	CAPA1000	7908155400090-0	0,17 (kg)	21,0 x 114,0 x 0,2 (cm)	10	29,5 x 39,0 x 8,0 (cm)	0,009 m³	1,81 (kg)

CARIOCA 2,00 m

REF.: GSL0267

**FPS
100****NCM
6601.91.10****TAMANHOS (Ø)** 1,60 m
2,00 m**HASTE** alumínio**SUMMER TRIP
2,00 m**

REF.: GSL0359

**FUN 2,00 m**

REF.: GSL0268

**PoÁ 1,60 m**

REF.: GSL0391

**TIE DIE 1,60 m**

REF.: GSL0407

**PRIMAVERA 1,60 m**

REF.: GLS0390



PRODUTO					EMBALAGEM			
GUARDA-SOL HASTE ALUMÍNIO	REFERÊNCIA	GTIN 13	PESO LÍQUIDO	TAMANHO ABERTO (LxCxA)	EMBALAGEM	TAMANHO (LxCxA)	VOLUME	PESO BRUTO
80x8 PVC - CARIOCA	GSL0263	790815540067-2	2,04 (kg)	160,0 x 160,0 x 190,0 (cm)	10	16,0 x 41,0 x 108,0 (cm)	0,070 m ³	21,79 (kg)
100x8 PVC - CARIOCA	GSL0267	790815540068-9	2,88 (kg)	200,0 x 200,0 x 210,0 (cm)	10	25,0 x 32,5 x 122,0 (cm)	0,075 m ³	30,16 (kg)
80x8 PVC - SUMMER TRIP	GSL0355	790815540071-9	2,04 (kg)	160,0 x 160,0 x 190,0 (cm)	10	16,0 x 41,0 x 108,0 (cm)	0,070 m ³	21,79 (kg)
100x8 PVC - SUMMER TRIP	GSL0359	790815540072-6	2,88 (kg)	200,0 x 200,0 x 210,0 (cm)	10	25,0 x 32,5 x 122,0 (cm)	0,075 m ³	30,16 (kg)
80x8 PVC - FUN	GSL0264	790815540073-3	2,04 (kg)	160,0 x 160,0 x 190,0 (cm)	10	16,0 x 41,0 x 108,0 (cm)	0,070 m ³	21,79 (kg)
100x8 PVC - FUN	GSL0268	790815540074-0	2,88 (kg)	200,0 x 200,0 x 210,0 (cm)	10	25,0 x 32,5 x 122,0 (cm)	0,075 m ³	30,16 (kg)
80x8 PVC - POÁ	GSL0391	790815540463-2	2,04 (kg)	160,0 x 160,0 x 190,0 (cm)	10	16,0 x 41,0 x 108,0 (cm)	0,070 m ³	21,79 (kg)
100x8 PVC - POÁ	GSL0403	790815540070-2	2,88 (kg)	200,0 x 200,0 x 210,0 (cm)	10	25,0 x 32,5 x 122,0 (cm)	0,075 m ³	30,16 (kg)
80x8 PVC - TIE DYE	GSL0407	790815540076-4	2,04 (kg)	160,0 x 160,0 x 190,0 (cm)	10	16,0 x 41,0 x 108,0 (cm)	0,070 m ³	21,79 (kg)
80x8 PVC - PRIMAVERA	GSL0390	790815540065-8	2,04 (kg)	160,0 x 160,0 x 190,0 (cm)	10	16,0 x 41,0 x 108,0 (cm)	0,070 m ³	21,79 (kg)
100x8 PVC - PRIMAVERA	GSL0402	790815540066-5	2,88 (kg)	200,0 x 200,0 x 210,0 (cm)	10	25,0 x 32,5 x 122,0 (cm)	0,075 m ³	30,16 (kg)

GUARDA-SOL LISTRADO

VERMELHO 1,60 m
 REF.: GSL0574

 MESA PARA GUARDA-SOL
 REF.: MEP2003

AZUL 1,60 m
 REF.: GSL0573

AMARELO 1,60 m
 REF.: GSL0572

PRODUTO					EMBALAGEM			
GUARDA-SOL HASTE ALUMÍNIO	REFERÊNCIA	GTIN 13	PESO LÍQUIDO	TAMANHO ABERTO (LxCxA)	EMBALAGEM	TAMANHO (LxCxA)	VOLUME	PESO BRUTO
80x8 PVC - LISTRAS VERMELHO	GSL0574	790815540081-8	2,04 (kg)	160,0 x 160,0 x 190,0 (cm)	10	16,0 x 41,0 x 108,0 (cm)	0,070 m ³	21,79 (kg)
100x8 PVC - LISTRAS VERMELHO	GSL0583	790815540082-5	2,88 (kg)	200,0 x 200,0 x 210,0 (cm)	10	25,0 x 32,5 x 122,0 (cm)	0,075 m ³	30,16 (kg)
80x8 PVC - LISTRAS AZUL	GSL0573	790815540435-9	2,04 (kg)	160,0 x 160,0 x 190,0 (cm)	10	16,0 x 41,0 x 108,0 (cm)	0,070 m ³	21,79 (kg)
100x8 PVC - LISTRAS AZUL	GSL0582	790815540081-8	2,88 (kg)	200,0 x 200,0 x 210,0 (cm)	10	25,0 x 32,5 x 122,0 (cm)	0,075 m ³	30,16 (kg)
80x8 PVC - LISTRAS AMARELO	GSL0572	790815540077-1	2,04 (kg)	160,0 x 160,0 x 190,0 (cm)	10	16,0 x 41,0 x 108,0 (cm)	0,070 m ³	21,79 (kg)
100x8 PVC - LISTRAS AMARELO	GSL0581	790815540079-5	2,88 (kg)	200,0 x 200,0 x 210,0 (cm)	10	25,0 x 32,5 x 122,0 (cm)	0,075 m ³	30,16 (kg)

REDONDO C/ ABAS
2,40 m

REF.: OMB0465



FPS
100

NCM
6601.91.10

TAMANHOS (Ø)



2,40 m
3,00 m

HASTE madeira - Ø 32 mm



5 OPÇÕES DE CORES

REDONDO S/ ABAS
2,40 m

REF.: OMB0485



FPS
100

NCM
6601.91.10

TAMANHOS (Ø)



2,00 m
2,40 m
3,00 m

HASTE madeira - Ø 32 mm



5 OPÇÕES DE CORES

PRODUTO				
OMBRELONE REDONDO	REFERÊNCIA	GTIN 13	PESO LÍQUIDO	TAMANHO ABERTO (LxCxA)
2,40m C/ABA - AMARELO	OMB0463	790815540143-3	6,84 (kg)	240,0 x 240,0 x 233,0 (cm)
2,40m C/ABA - LARANJA	OMB0464	790815540144-0	6,84 (kg)	240,0 x 240,0 x 233,0 (cm)
2,40m C/ABA - AZUL ROYAL	OMB0465	790815540145-7	6,84 (kg)	240,0 x 240,0 x 233,0 (cm)
2,40m C/ABA - VD. PRIMAVERA	OMB0467	790815540147-1	6,84 (kg)	240,0 x 240,0 x 233,0 (cm)
2,40m C/ABA - ROXO	OMB0468	790815540148-8	6,84 (kg)	240,0 x 240,0 x 233,0 (cm)
3,00m C/ABA - AMARELO	OMB0469	790815540151-8	10,30 (kg)	300,0 x 300,0 x 266,0 (cm)
3,00m C/ABA - LARANJA	OMB0470	790815540152-5	10,30 (kg)	300,0 x 300,0 x 266,0 (cm)
3,00m C/ABA - AZUL ROYAL	OMB0471	790815540153-2	10,30 (kg)	300,0 x 300,0 x 266,0 (cm)
3,00m C/ABA - VD. PRIMAVERA	OMB0473	790815540155-6	10,30 (kg)	300,0 x 300,0 x 266,0 (cm)
3,00m C/ABA - ROXO	OMB0474	790815540156-3	10,30 (kg)	300,0 x 300,0 x 266,0 (cm)

EMBALAGEM			
EMBALAGEM	TAMANHO (LxCxA)	VOLUME	PESO BRUTO
01	16,0 x 18,5 x 135,5 (cm)	0,040 m³	7,58 (kg)
01	16,0 x 18,5 x 135,5 (cm)	0,040 m³	7,58 (kg)
01	16,0 x 18,5 x 135,5 (cm)	0,040 m³	7,58 (kg)
01	16,0 x 18,5 x 135,5 (cm)	0,040 m³	7,58 (kg)
01	16,0 x 18,5 x 135,5 (cm)	0,040 m³	7,58 (kg)
01	16,0 x 16,5 x 166,5 (cm)	0,044 m³	10,81 (kg)
01	16,0 x 16,5 x 166,5 (cm)	0,044 m³	10,81 (kg)
01	16,0 x 16,5 x 166,5 (cm)	0,044 m³	10,81 (kg)
01	16,0 x 16,5 x 166,5 (cm)	0,044 m³	10,81 (kg)
01	16,0 x 16,5 x 166,5 (cm)	0,044 m³	10,81 (kg)

PRODUTO				
OMBRELONE REDONDO	REFERÊNCIA	GTIN 13	PESO LÍQUIDO	TAMANHO ABERTO (LxCxA)
2,00m S/ABA - BRANCO	OMB0274	790815540124-2	5,12 (kg)	200,0 x 200,0 x 233,0 (cm)
2,00m S/ABA - AMARELO	OMB0475	790815540125-9	5,12 (kg)	200,0 x 200,0 x 233,0 (cm)
2,00m S/ABA - LARANJA	OMB0476	790815540126-6	5,12 (kg)	200,0 x 200,0 x 233,0 (cm)
2,00m S/ABA - AZUL ROYAL	OMB0477	790815540127-3	5,12 (kg)	200,0 x 200,0 x 233,0 (cm)
2,00m S/ABA - VD. PRIMAVERA	OMB0479	790815540129-7	5,12 (kg)	200,0 x 200,0 x 233,0 (cm)
2,00m S/ABA - ROXO	OMB0480	790815540130-3	5,12 (kg)	200,0 x 200,0 x 233,0 (cm)
2,40m S/ABA - BRANCO	OMB0154	790815540132-7	6,79 (kg)	240,0 x 240,0 x 233,0 (cm)
2,40m S/ABA - AMARELO	OMB0481	790815540133-4	6,79 (kg)	240,0 x 240,0 x 233,0 (cm)
2,40m S/ABA - LARANJA	OMB0482	790815540134-1	6,79 (kg)	240,0 x 240,0 x 233,0 (cm)
2,40m S/ABA - AZUL ROYAL	OMB0483	790815540134-1	6,79 (kg)	240,0 x 240,0 x 233,0 (cm)
2,40m S/ABA - VD. PRIMAVERA	OMB0485	790815540137-2	6,79 (kg)	240,0 x 240,0 x 233,0 (cm)
2,40m S/ABA - ROXO	OMB0486	790815540138-9	6,79 (kg)	240,0 x 240,0 x 233,0 (cm)
3,00m S/ABA - BRANCO	OMB0164	790815540158-7	9,60 (kg)	240,0 x 240,0 x 266,0 (cm)
3,00m S/ABA - AMARELO	OMB0487	790815540159-4	9,60 (kg)	240,0 x 240,0 x 266,0 (cm)
3,00m S/ABA - LARANJA	OMB0488	790815540160-0	9,60 (kg)	240,0 x 240,0 x 266,0 (cm)
3,00m S/ABA - AZUL ROYAL	OMB0489	790815540161-7	9,60 (kg)	240,0 x 240,0 x 266,0 (cm)
3,00m S/ABA - VD. PRIMAVERA	OMB0491	790815540163-1	9,60 (kg)	240,0 x 240,0 x 266,0 (cm)
3,00m S/ABA - ROXO	OMB0492	790815540164-8	9,60 (kg)	240,0 x 240,0 x 266,0 (cm)

EMBALAGEM			
EMBALAGEM	TAMANHO (LxCxA)	VOLUME	PESO BRUTO
01	16,0 x 18,5 x 135,5 (cm)	0,040 m³	6,22 (kg)
01	16,0 x 18,5 x 135,5 (cm)	0,040 m³	6,22 (kg)
01	16,0 x 18,5 x 135,5 (cm)	0,040 m³	6,22 (kg)
01	16,0 x 18,5 x 135,5 (cm)	0,040 m³	6,22 (kg)
01	16,0 x 18,5 x 135,5 (cm)	0,040 m³	6,22 (kg)
01	16,0 x 18,5 x 135,5 (cm)	0,040 m³	6,22 (kg)
01	16,0 x 18,5 x 135,5 (cm)	0,040 m³	6,97 (kg)
01	16,0 x 18,5 x 135,5 (cm)	0,040 m³	6,97 (kg)
01	16,0 x 18,5 x 135,5 (cm)	0,040 m³	6,97 (kg)
01	16,0 x 18,5 x 135,5 (cm)	0,040 m³	6,97 (kg)
01	16,0 x 18,5 x 135,5 (cm)	0,040 m³	6,97 (kg)
01	16,0 x 16,5 x 166,5 (cm)	0,044 m³	10,46 (kg)
01	16,0 x 16,5 x 166,5 (cm)	0,044 m³	10,46 (kg)
01	16,0 x 16,5 x 166,5 (cm)	0,044 m³	10,46 (kg)
01	16,0 x 16,5 x 166,5 (cm)	0,044 m³	10,46 (kg)

**QUADRADO
C/ ABAS 2,10 m**

REF.: OMB0341

**FPS
100**
**NCM
9401.79.00**
TAMANHOS (Ø)

 1,65 m
2,10 m

HASTE madeira - Ø 32 mm

5 OPÇÕES DE CORES

**QUADRADO
S/ ABAS 2,10 m**

REF.: OMB0503

TAMANHOS (Ø)

 1,65 m
2,10 m

HASTE madeira - Ø 32 mm

5 OPÇÕES DE CORES

QUIOSQUE S/ ABAS

REF.: OMB0290

TAMANHOS (Ø)

3,00 m

HASTE madeira - Ø 45 mm

3 OPÇÕES DE CORES

PRODUTO				
OMBRELONE QUADRADO	REFERÊNCIA	GTIN 13	PESO LÍQUIDO	TAMANHO ABERTO (LxCxA)
1,65m C/ABA - AMARELO	OMB0334	790815540093-1	4,61 (kg)	1650 x 1650 x 233,0 (cm)
1,65m C/ABA - LARANJA	OMB0335	790815540094-8	4,61 (kg)	1650 x 1650 x 233,0 (cm)
1,65m C/ABA - AZUL ROYAL	OMB0336	790815540095-5	4,61 (kg)	1650 x 1650 x 233,0 (cm)
1,65m C/ABA - VD PRIMAVERA	OMB0338	790815540097-9	4,61 (kg)	1650 x 1650 x 233,0 (cm)
1,65m C/ABA - ROXO	OMB0339	790815540098-6	4,61 (kg)	1650 x 1650 x 233,0 (cm)
2,10m C/ABA - AMARELO	OMB0341	790815540109-9	6,48 (kg)	210,0 x 210,0 x 266,0 (cm)
2,10m C/ABA - LARANJA	OMB0342	790815540110-5	6,48 (kg)	210,0 x 210,0 x 266,0 (cm)
2,10m C/ABA - AZUL ROYAL	OMB0343	790815540111-2	6,48 (kg)	210,0 x 210,0 x 266,0 (cm)
2,10m C/ABA - VD PRIMAVERA	OMB0344	790815540112-9	6,48 (kg)	210,0 x 210,0 x 266,0 (cm)
2,10m C/ABA - ROXO	OMB0346	790815540114-3	6,48 (kg)	210,0 x 210,0 x 266,0 (cm)

EMBALAGEM			
EMBALAGEM	TAMANHO (LxCxA)	VOLUME	PESO BRUTO
01	13,5x 14,0 x 133,0 (cm)	0,025 m³	5,19 (kg)
01	13,5x 14,0 x 133,0 (cm)	0,025 m³	5,19 (kg)
01	13,5x 14,0 x 133,0 (cm)	0,025 m³	5,19 (kg)
01	13,5x 14,0 x 133,0 (cm)	0,025 m³	5,19 (kg)
01	13,5x 14,0 x 133,0 (cm)	0,025 m³	5,19 (kg)
01	16,0 x 16,5 x 166,5 (cm)	0,044 m³	7,30 (kg)
01	16,0 x 16,5 x 166,5 (cm)	0,044 m³	7,30 (kg)
01	16,0 x 16,5 x 166,5 (cm)	0,044 m³	7,30 (kg)
01	16,0 x 16,5 x 166,5 (cm)	0,044 m³	7,30 (kg)
01	16,0 x 16,5 x 166,5 (cm)	0,044 m³	7,30 (kg)

PRODUTO				
OMBRELONE QUADRADO	REFERÊNCIA	GTIN 13	PESO LÍQUIDO	TAMANHO ABERTO (LxCxA)
1,65m S/ABA - AMARELO	OMB0493	790815540101-3	4,54 (kg)	1650 x 1650 x 233,0 (cm)
1,65m S/ABA - ESPECIAL	OMB0148	790815540107-5	4,54 (kg)	1650 x 1650 x 233,0 (cm)
1,65m S/ABA - LARANJA	OMB0494	790815540102-0	4,54 (kg)	1650 x 1650 x 233,0 (cm)
1,65m S/ABA - ROXO	OMB0498	790815540106-8	4,54 (kg)	1650 x 1650 x 233,0 (cm)
1,65m S/ABA - VD PRIMAVERA	OMB0497	790815540105-1	4,54 (kg)	1650 x 1650 x 233,0 (cm)
1,65m S/ABA - AZUL ROYAL	OMB0495	790815540103-7	4,54 (kg)	1650 x 1650 x 233,0 (cm)
2,10m S/ABA - AMARELO	OMB0499	790815540117-4	6,16 (kg)	210,0 x 210,0 x 266,0 (cm)
2,10m S/ABA - LARANJA	OMB0500	790815540118-1	6,16 (kg)	210,0 x 210,0 x 266,0 (cm)
2,10m S/ABA - AZUL ROYAL	OMB0501	790815540119-8	6,16 (kg)	210,0 x 210,0 x 266,0 (cm)
2,10m S/ABA - VD. PRIMAVERA	OMB0503	790815540121-1	6,16 (kg)	210,0 x 210,0 x 266,0 (cm)
2,10m S/ABA - ROXO	OMB0504	790815540122-8	6,16 (kg)	210,0 x 210,0 x 266,0 (cm)

EMBALAGEM			
EMBALAGEM	TAMANHO (LxCxA)	VOLUME	PESO BRUTO
01	13,5x 14,0 x 133,0 (cm)	0,025 m³	5,12 (kg)
01	13,5x 14,0 x 133,0 (cm)	0,025 m³	5,12 (kg)
01	13,5x 14,0 x 133,0 (cm)	0,025 m³	5,12 (kg)
01	13,5x 14,0 x 133,0 (cm)	0,025 m³	5,12 (kg)
01	13,5x 14,0 x 133,0 (cm)	0,025 m³	5,12 (kg)
01	13,5x 14,0 x 133,0 (cm)	0,025 m³	5,12 (kg)
01	16,0 x 16,5 x 166,5 (cm)	0,044 m³	6,99 (kg)
01	16,0 x 16,5 x 166,5 (cm)	0,044 m³	6,99 (kg)
01	16,0 x 16,5 x 166,5 (cm)	0,044 m³	6,99 (kg)
01	16,0 x 16,5 x 166,5 (cm)	0,044 m³	6,99 (kg)
01	16,0 x 16,5 x 166,5 (cm)	0,044 m³	6,99 (kg)

PRODUTO				
OMBRELONE QUADRADO	REFERÊNCIA	GTIN 13	PESO LÍQUIDO	TAMANHO ABERTO (LxCxA)
3,00m S/ABA - QUIOSQUE	OMB0290	790815540101-3	8,25 (kg)	300,0 x 300,0 x 295,0 (cm)

EMBALAGEM			
EMBALAGEM	TAMANHO (LxCxA)	VOLUME	PESO BRUTO
01	---	---	---

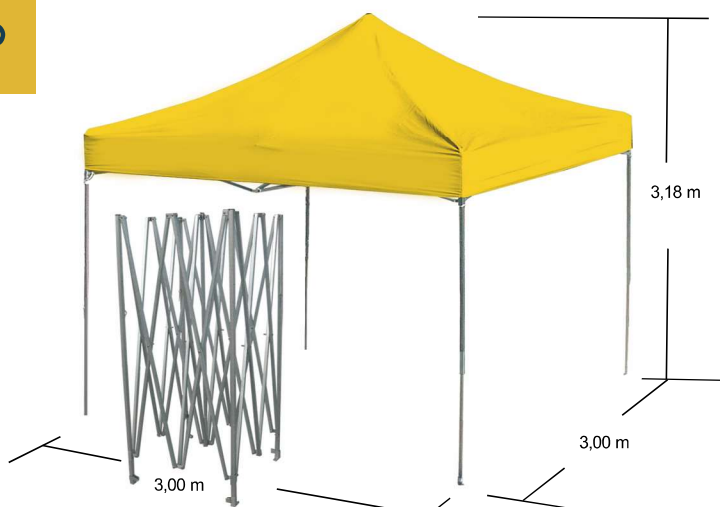
**GAZEBO
PANTOGRÁFICO**
 REF.: TEN0513

NCM
 9401.79.00

5 OPÇÕES DE CORES

MESA PRÁTICA

REF.: MEP2001



EMBALAGEM COMPACTA

PRODUTO

MESA PRÁTICA	REFERÊNCIA	GTIN 13	PESO LÍQUIDO	TAMANHO ABERTO (LxCxA)
COM 4 BANQUETAS	MEP2001	790815540531-8	5,90 (kg)	66,0 x 69,0 x 80,0 (cm)

EMBALAGEM

EMBALAGEM	TAMANHO (LxCxA)	VOLUME	PESO BRUTO
01	71,0 x 14,5 x 45,5 (cm)	0,046 m³	6,63 (kg)

PRODUTO

GAZEBO PANTOGRÁFICO	REFERÊNCIA	GTIN 13	PESO LÍQUIDO	TAMANHO ABERTO (LxCxA)
2x2m - AMARELO	TEN0506	790815540244-7	23,12 (kg)	195,0 x 195,0 x 296,0 (cm)
2x2m - LARANJA	TEN0507	790815540245-4	23,12 (kg)	195,0 x 195,0 x 296,0 (cm)
2x2m - AZ.ROYAL	TEN0508	790815540248-5	23,12 (kg)	195,0 x 195,0 x 296,0 (cm)
2x2m - VD. PRIMAVERA	TEN0510	790815540247-8	23,12 (kg)	195,0 x 195,0 x 296,0 (cm)
2x2m - ROXO	TEN0511	790815540249-2	23,12 (kg)	195,0 x 195,0 x 296,0 (cm)
3x3m - AMARELO	TEN0513	790815540252-2	36,11 (kg)	300,0 x 300,0 x 318,0 (cm)
3x3m - LARANJA	TEN0514	790815540253-9	36,11 (kg)	300,0 x 300,0 x 318,0 (cm)
3x3m - AZ. ROYAL	TEN0515	790815540256-0	36,11 (kg)	300,0 x 300,0 x 318,0 (cm)
3x3m - VD. PRIMAVERA	TEN0517	790815540255-3	36,11 (kg)	300,0 x 300,0 x 318,0 (cm)
3x3m - ROXO	TEN0518	790815540257-7	36,11 (kg)	300,0 x 300,0 x 318,0 (cm)

EMBALAGEM

EMBALAGEM	TAMANHO (LxCxA)	VOLUME	PESO BRUTO
01	29,0 x 28,0 x 153,0 (cm)	0,124 m³	24,46 (kg)
01	29,0 x 28,0 x 153,0 (cm)	0,124 m³	24,46 (kg)
01	29,0 x 28,0 x 153,0 (cm)	0,124 m³	24,46 (kg)
01	29,0 x 28,0 x 153,0 (cm)	0,124 m³	24,46 (kg)
01	29,0 x 28,0 x 153,0 (cm)	0,124 m³	24,46 (kg)
01	29,0 x 28,0 x 153,0 (cm)	0,124 m³	36,98 (kg)
01	29,0 x 28,0 x 153,0 (cm)	0,124 m³	36,98 (kg)
01	29,0 x 28,0 x 153,0 (cm)	0,124 m³	36,98 (kg)
01	29,0 x 28,0 x 153,0 (cm)	0,124 m³	36,98 (kg)
01	29,0 x 28,0 x 153,0 (cm)	0,124 m³	36,98 (kg)

TAMANHOS (Ø)

1,40 m
1,60 m
1,80 m
2,00 m

HASTE

alumínio
madeira



GUARDA-SOL

TAMANHOS (Ø)

REDONDO c/ ABAS	2,40 m 3,00 m
REDONDO s/ ABAS	2,00 m 2,40 m 3,00 m
QUADRADO c/ ABAS	1,65 m 2,10 m
QUADRADO s/ ABAS	1,65 m 2,10 m
QUIOSQUE s/ ABAS	3,00 m



OMBRELONE



CADEIRA DE PRAIA



GAZEBO



www.botafogo.ind.br

Estrada RJ 127 - Lote 08 - Parte Loteamento Industrial
Lages - Paracambi - RJ - CEP: 26600-000 - Fone:(+55) 21 2683-8450

