

stam

Linha
Ferraggio[®]



BELEZA
SOFISTICAÇÃO
DURABILIDADE



Linha
Ferraggio[®]

Ambientes com personalidade, estilo e elegância.
Aliando sofisticação e design, a Linha Ferraggio Stam foi projetada para consumidores exigentes, que buscam produtos com requinte, alto padrão de qualidade e matéria-prima nobre, com mais resistência à corrosão e longa durabilidade.

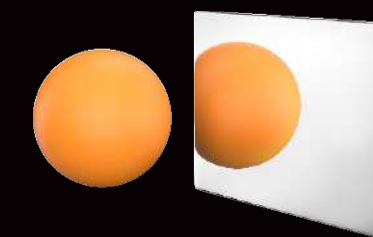

Inox Polido

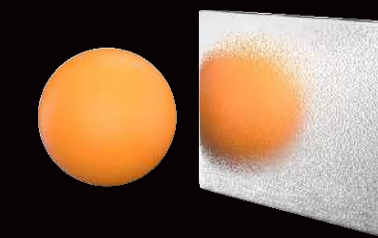

Inox Escovado

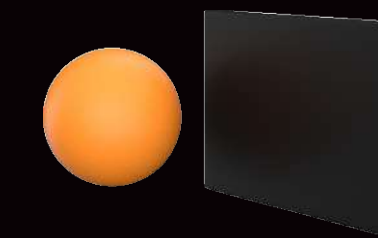

Black

PUXADORES DE PORTA



LISBOA 2500
Pág 08



BRAGA 2500
Pág 12



MADRID 2525
Pág 16



BARCELONA 2525
Pág 20



RAVENNA 3010
Pág 24



VERONA 3015
Pág 28



ROMA 3015
Pág 32



MILANO 4020
Pág 36



MONZA 2020
Pág 40

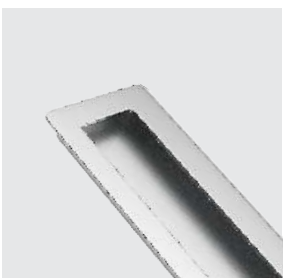

CONCHA
Pág 44

KITS PARA PORTA DE CORRER



CRYSTAL
Pág 48



SMART
Pág 50

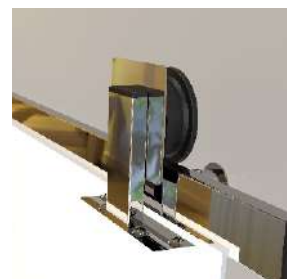

FIT
Pág 52



MASTER
Pág 54



IPANEMA F1
Pág 56



IPANEMA C1
Pág 58

DOBRADIÇAS



DE EMBUTIR
Pág 62



DE SOBREPOR
Pág 64



PINO PIVOTANTE
Pág 66

ACESSÓRIOS



FECHO MAGNÉTICO
Pág 70



FIXADOR MAGNÉTICO
Pág 72



FECHO BATOM
Pág 74



BATENTE DE PORTA
Pág 76



VISOR DE PORTA
Pág 78

BARRA DE APOIO

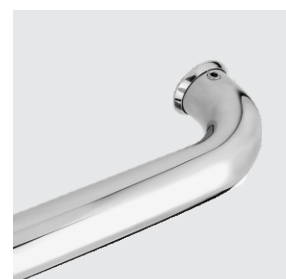

BARRA DE APOIO
Pág 82

PÉ DE MESA



PÉ DE MESA
Pág 86



Sam

PUXADORES



PUXADOR
LISBOA
2500

LISBOA 2500



CONHEÇA A FECHADURA STAM
COM TRINCO ROLETE
PARA PORTAS PIVOTANTES
1005

PUXADOR SIMPLES			PUXADOR DUPLO			
	I. Esc.	I. Polido	I. Esc.	I. Polido	Black	
400mm	76033	76033	400mm	76024	76025	76807
600mm	76034	76035	600mm	76026	76027	76808
800mm	76036	76037	800mm	76028	76029	76806
1000mm	76039		1000mm	76030	76031	



FABRICADO COM
AÇO INOX 304

Composição
> Aço inox 304 / Aço / ABS / Alumínio

Aplicação
> Puxador para portas de madeira ou vidro.

Especificação
> Puxador duplo tubular com perfil Ø25mm produzido em aço inox 304
> Sistema de fixação externa que contribui para segurança*.
*sem parafusos externos aparentes

Tamanho (milímetros)
> 400 / 600 / 800 / 1000mm
(Comprimento total - mm)

Modelo	Distância Entre Furos
400mm	300mm
600mm	500mm
800mm	600mm
1000mm	800mm



TUBULAR

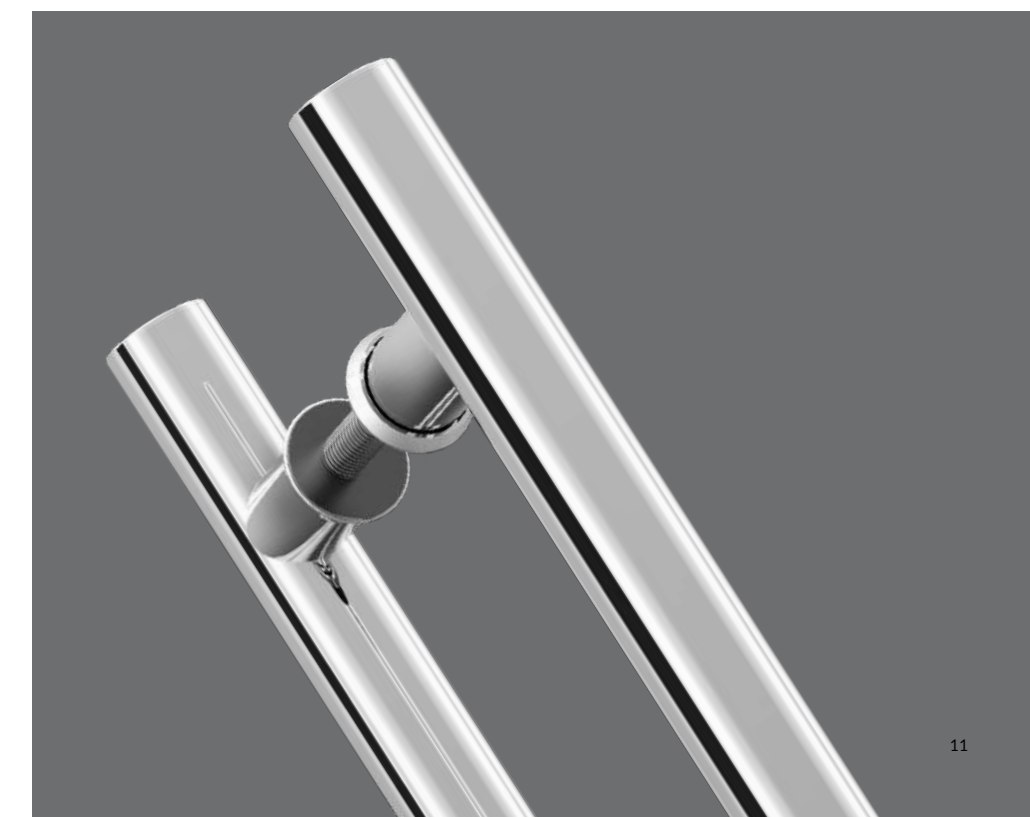
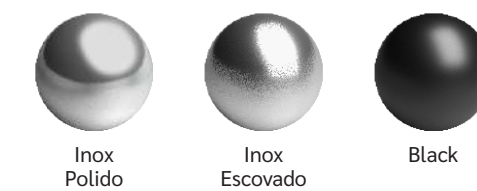



PUXADOR
BRAGA
2500

BRAGA 2500

CONHEÇA A
FECHADURA STAM
PARA PORTAS DE CORRER
1006

**PUXADOR
DUPLO**

I. Esc. I. Polido
600mm * 76649
800mm * 76650
* Sob Consulta

FABRICADO COM

AÇO INOX 304

Composição

> Aço inox 304 / Aço / PVC / Alumínio / SS201

Aplicação

> Puxador para portas de madeira ou vidro.

Especificação

> Puxador duplo tubular com perfil Ø25mm produzido em aço inox 304
> Sistema de fixação externa que contribui para segurança*.
*sem parafusos externos aparentes
> Sistema de regulagem.

Tamanho (milímetros)

> 600 / 800mm
(Comprimento total - mm)

Modelo	Distância Entre Furos Regulável com Sistema Exclusivo Stam
600mm	
800mm	



TUBULAR

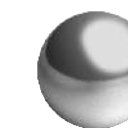

Inox Polido

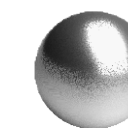

Inox Escovado



EXCLUSIVO
SISTEMA
DE REGULAGEM



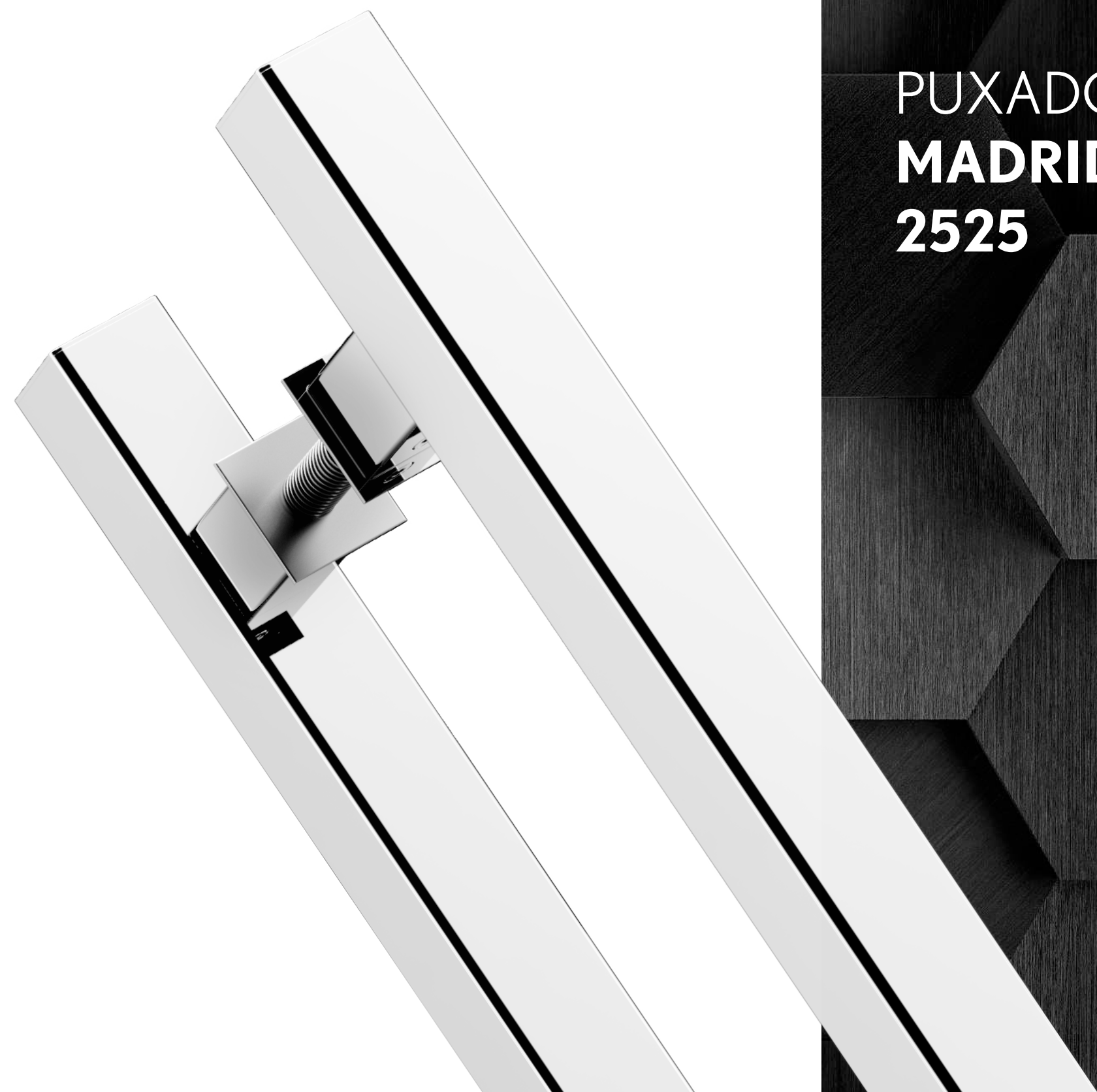

PUXADOR
MADRID
2525

MADRID 2525



CONHEÇA A FECHADURA STAM
COM TRINCO ROLETE
PARA PORTAS PIVOTANTES
1601

PUXADOR SIMPLES		PUXADOR DUPLO	
I. Esc.	I. Polido	I. Esc.	I. Polido
400mm	76081	400mm	76072 76073
600mm	76083	600mm	76074 76075
800mm	76085	800mm	76076 76077
1000mm	76087	1000mm	76078 76079

FABRICADO COM
AÇO INOX 304

Composição
> Aço inox 304 / Aço / PVC / ABS / Alumínio

Aplicação
> Puxador para portas de madeira ou vidro.

Especificação
> Puxador duplo quadrado com perfil 25x25mm produzido em aço inox 304
> Sistema de fixação externa que contribui para segurança*.
*sem parafusos externos aparentes

Tamanho (milímetros)
> 400 / 600 / 800 / 1000mm
(Comprimento total - mm)

Modelo	Distância Entre Furos
400mm	300mm
600mm	500mm
800mm	600mm
1000mm	800mm



QUADRADO



Inox Polido

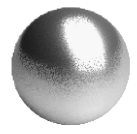

Inox Escovado



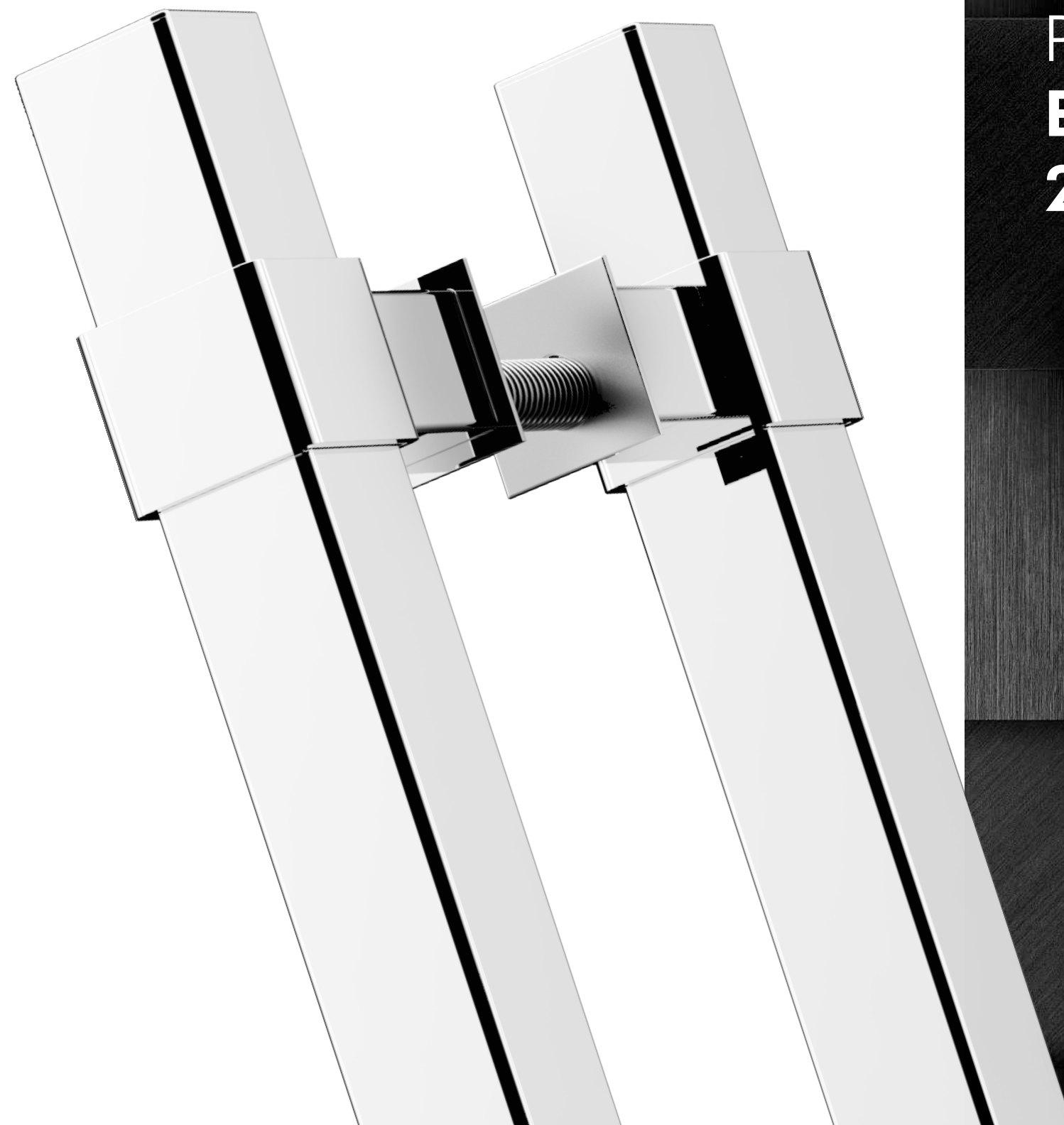

PUXADOR
BARCELONA
2525

BARCELONA 2525

CONHEÇA A FECHADURA STAM
COM TRINCO ROLETE
PARA PORTAS PIVOTANTES
800

**PUXADOR
DUPLO**

	I. Esc.	I. Polido
600mm	76543	76544
800mm	76546	76547
1000mm	76548	76549
1200mm	76551	76552
1500mm	76553	76554

FABRICADO COM

AÇO INOX 304

Composição

> Aço inox 304 / Aço / PVC / ABS / Zamac / Alumínio

Aplicação

> Puxador para portas de madeira ou vidro.

Especificação

> Puxador duplo quadrado com perfil 25x25mm produzido em aço inox 304

> Sistema de fixação externa que contribui para segurança*.

*sem parafusos externos aparentes

> Sistema de regulagem em Aço Inox 304.

Tamanho (milímetros)

600 / 800 / 1000 / 1200 / 1500mm

(Comprimento total - mm)

Modelo	Distância Entre Furos Regulável com Sistema Exclusivo Stam
300mm	
500mm	
600mm	
800mm	
1000mm	
1200mm	
1500mm	

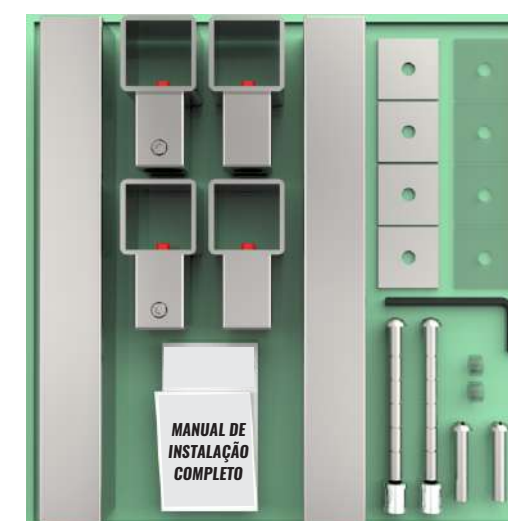

QUADRADO

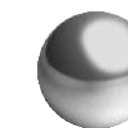

Inox Polido

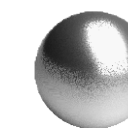

Inox Escovado

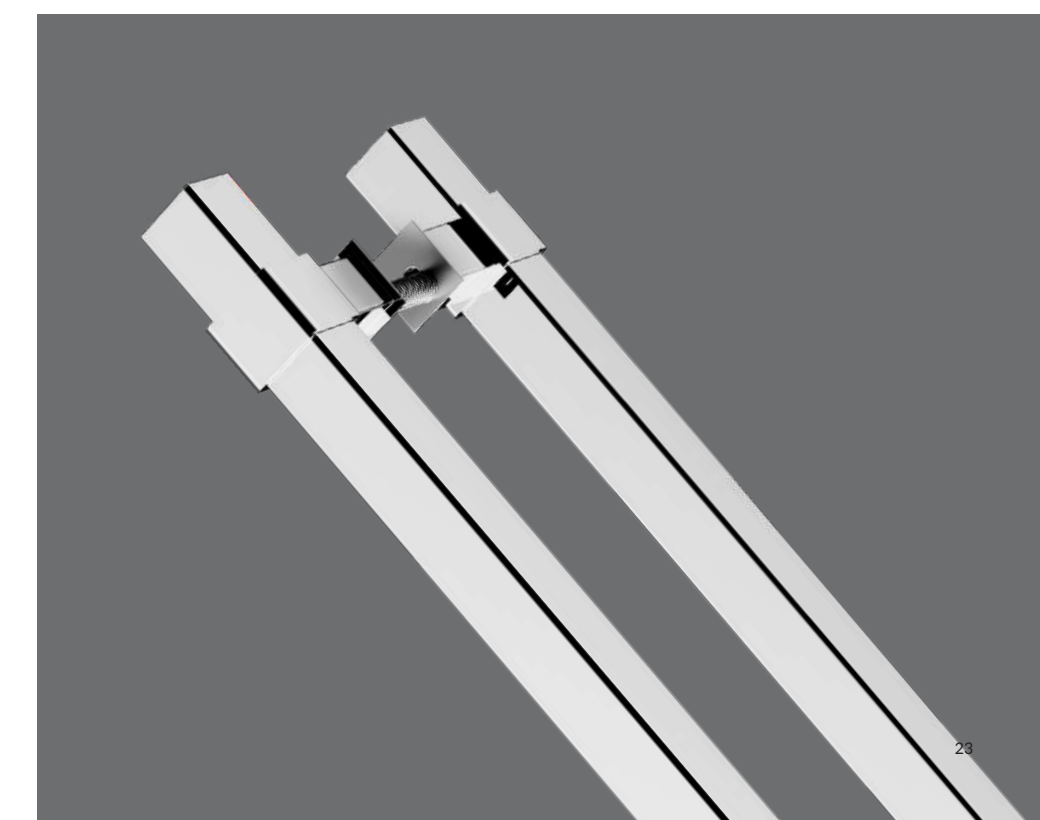

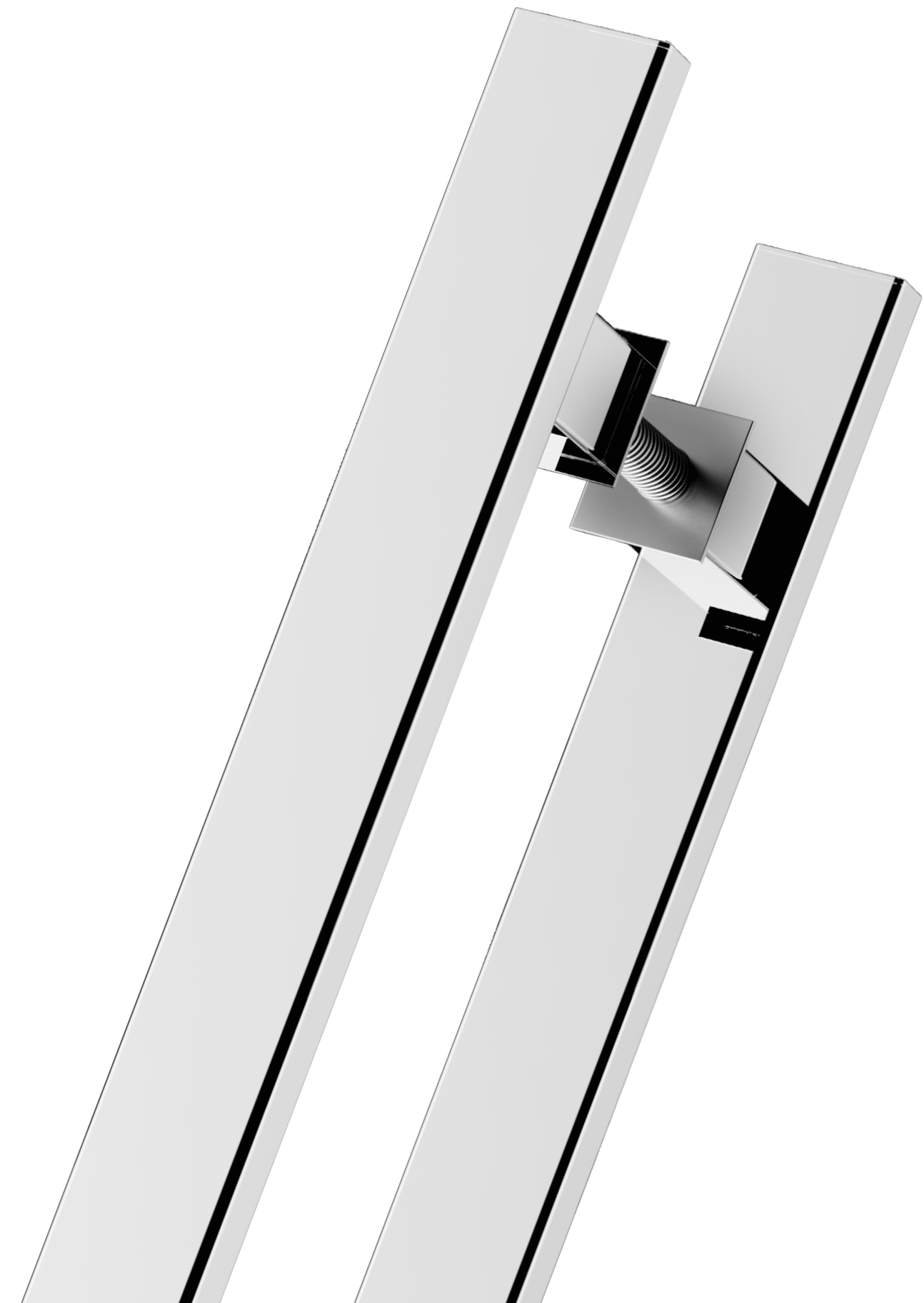

PUXADOR
RAVENNA
3010

RAVENNA 3010

CONHEÇA A
FECHADURA ELETRÔNICA
STAM by iTec
iMCode 02 PIN

PUXADOR SIMPLES

	I. Esc.	I. Polido
400mm	76048	76049
600mm	76050	76051
800mm	-----	76053
1000mm	76054	76055

PUXADOR DUPLO

	I. Esc.	I. Polido	Black
400mm	76040	76041	-----
600mm	76042	76043	76881
800mm	76044	76045	76802
1000mm	76046	76047	76800

FABRICADO COM

AÇO INOX 304

Composição

> Aço inox 304 / Aço / PVC / ABS / Alumínio

Aplicação

> Puxador para portas de madeira ou vidro.

Especificação

> Puxador duplo retangular com perfil 30x10mm produzido em aço inox 304

> Sistema de fixação externa que contribui para segurança*.

*sem parafusos externos aparentes

Tamanho (milímetros)

> 400 / 600 / 800 / 1000mm

(Comprimento total - mm)

Modelo	Distância Entre Furos
400mm	300mm
600mm	500mm
800mm	600mm
1000mm	800mm

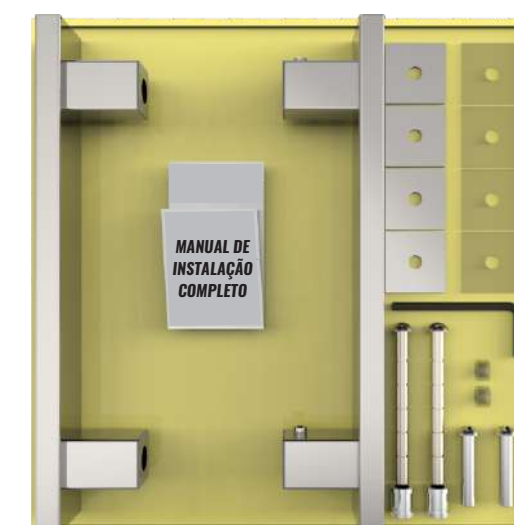

RETANGULAR

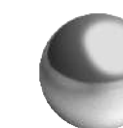

Inox Polido

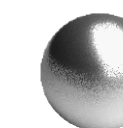

Inox Escovado

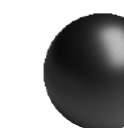

Black



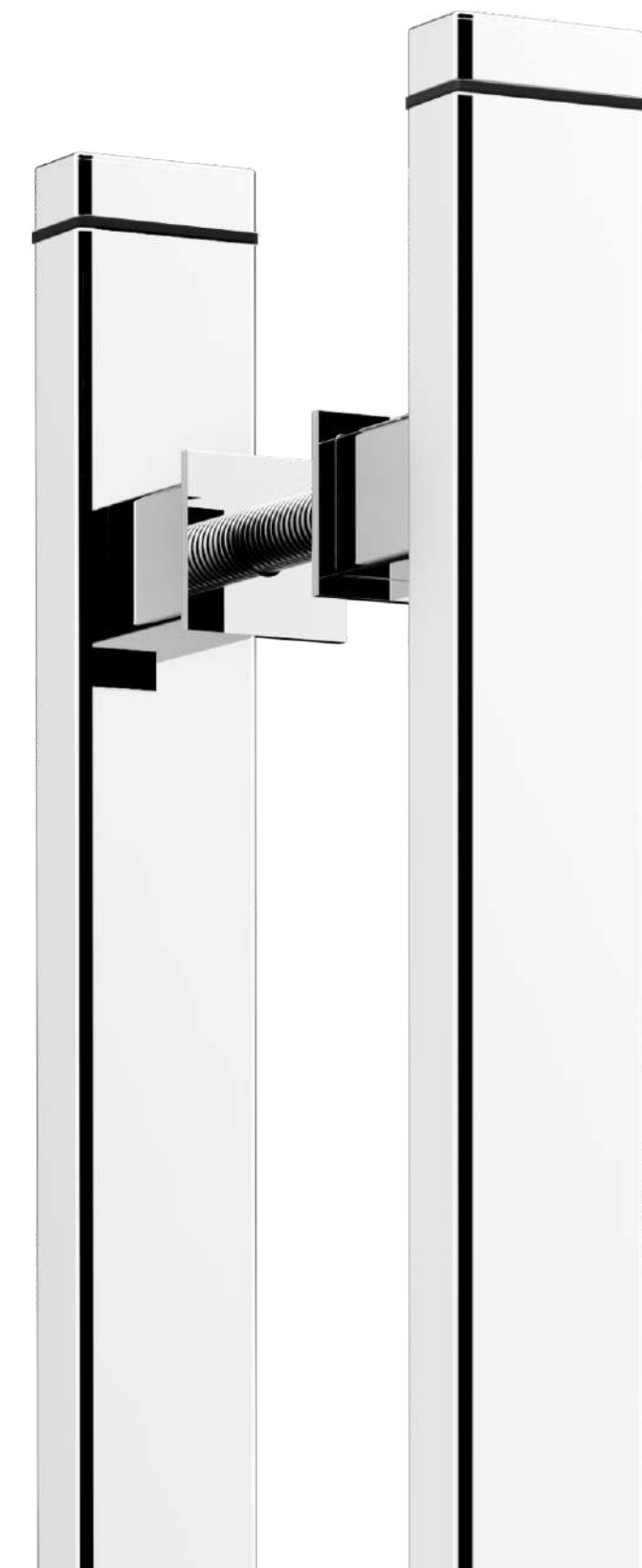

PUXADOR
VERONA
3015

VERONA 3015

CONHEÇA A FECHADURA STAM
COM TRINCO ROLETE
PARA PORTAS PIVOTANTES
1005

**PUXADOR
DUPLO**

I. Esc. I. Polido
400mm 76314 76312
600mm 76318 76316
800mm 76322 76320
1000mm 76326 76324

FABRICADO COM

AÇO INOX 304

Composição

> Aço inox 304 / Aço / PVC / ABS / Nylon / Alumínio

Aplicação

> Puxador para portas de madeira ou vidro.

Especificação

> Puxador duplo retangular com perfil 30x15mm produzido em aço inox 304

> Sistema de fixação externa que contribui para segurança*.

*sem parafusos externos aparentes

> Detalhe em nylon.

Tamanho (milímetros)

> 400 / 600 / 800 / 1000mm

(Comprimento total - mm)

Modelo	Distância Entre Furos
400mm	300mm
600mm	500mm
800mm	600mm
1000mm	800mm



RETANGULAR

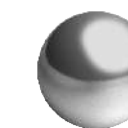

Inox Polido

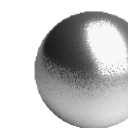

Inox Escovado

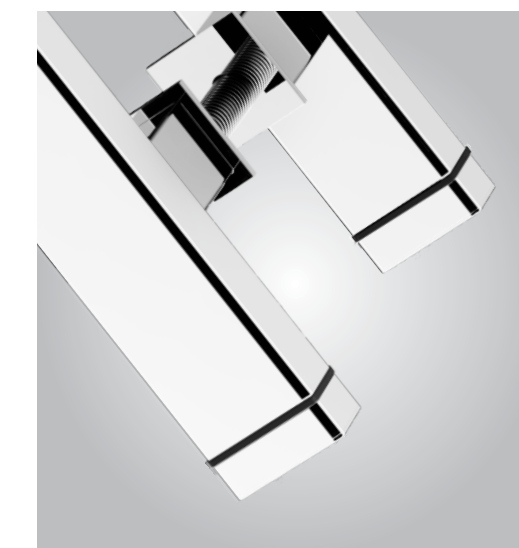

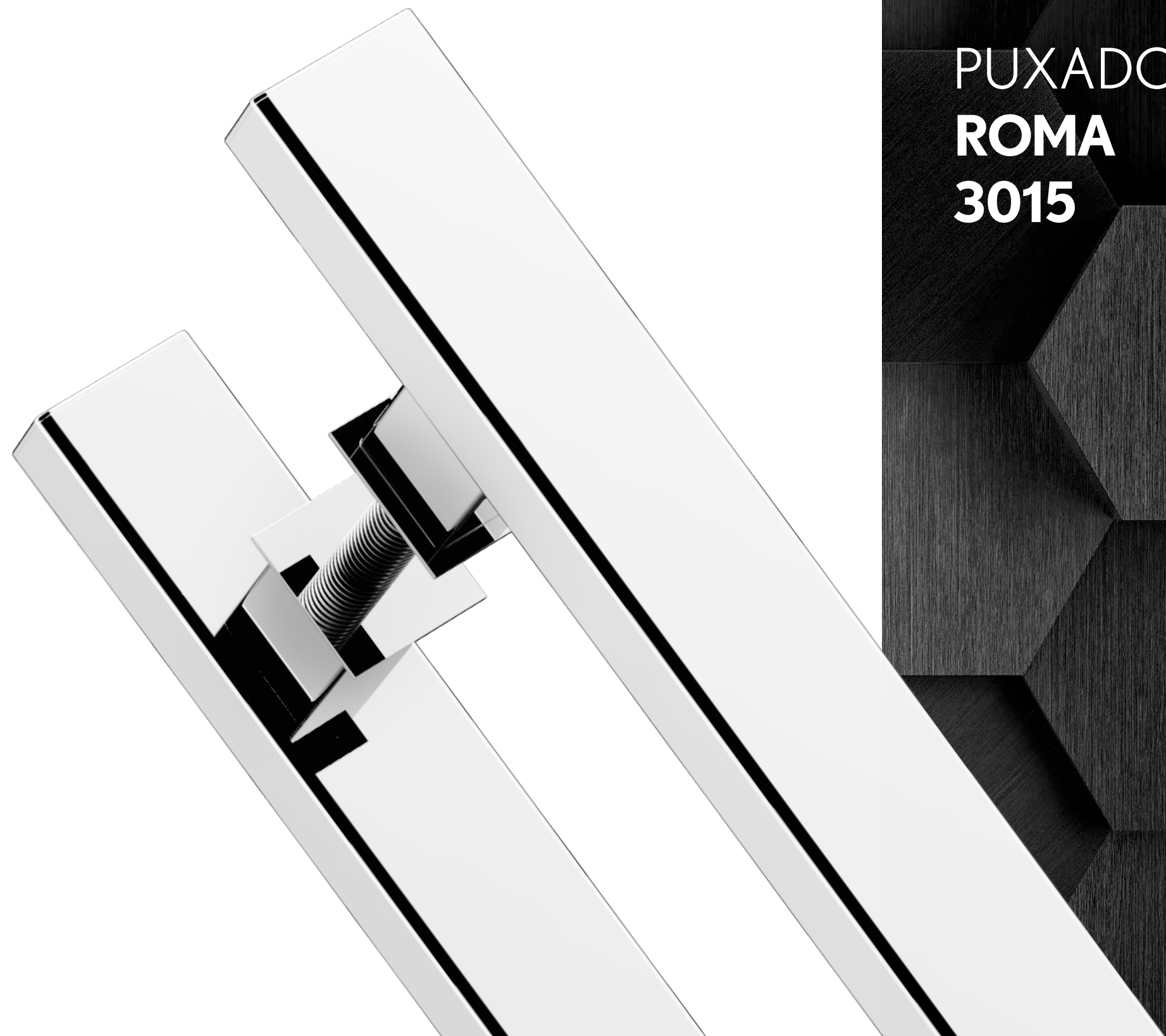

PUXADOR
ROMA
3015

ROMA 3015

CONHEÇA A
FECHADURA STAM
PARA PORTAS DE CORRER
950WC

**PUXADOR
DUPLO**

	I. Esc.	I. Polido
400mm	76563	76564
600mm	76567	76568
800mm	76569	76570
1000mm	76571	76572
1200mm	76573	76574
1500mm	76575	76576

FABRICADO COM

AÇO INOX 304

Composição

> Aço Inox 304 / Aço / PVC / ABS / Nylon / Alumínio

Aplicação

> Puxador para portas de madeira ou vidro.

Especificação

> Puxador duplo retangular com perfil 30x15mm em aço inox 304

> Sistema de fixação externa que contribui para segurança*.

*sem parafusos externos aparentes

Tamanho (milímetros)

> 400 / 600 / 800 / 1000 / 1200 / 1500mm

(Comprimento total - mm)

Modelo	Distância Entre Furos
200mm	150mm
300mm	200mm
400mm	300mm
600mm	500mm
800mm	600mm
1000mm	800mm
1200mm	1000mm
1500mm	1300mm



RETANGULAR

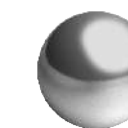

Inox Polido

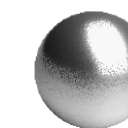

Inox Escovado





PUXADOR
MILANO
4020

MILANO 4020

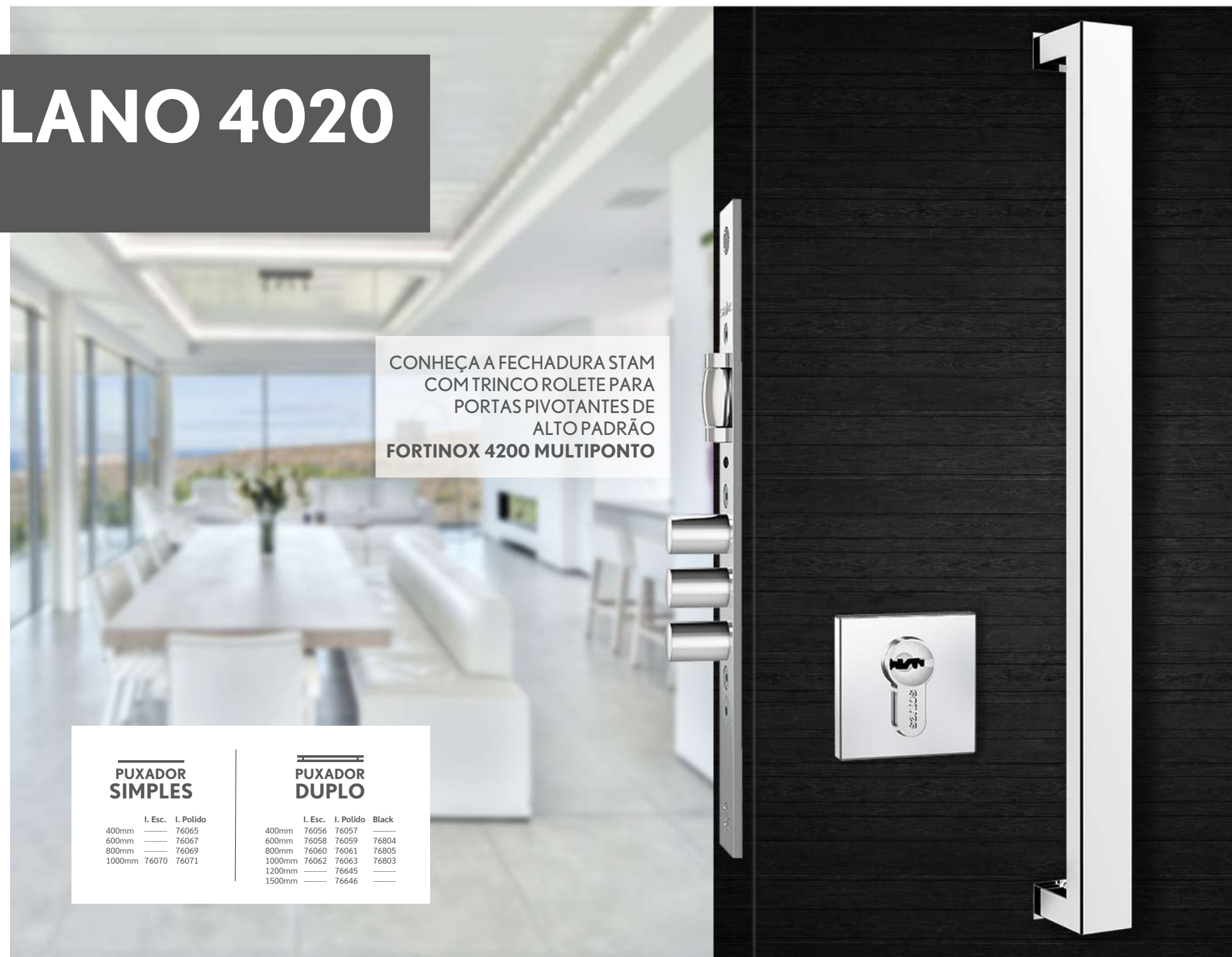

CONHEÇA A FECHADURA STAM
COM TRINCO ROLETE PARA
PORTAS PIVOTANTES DE
ALTO PADRÃO
FORTINOX 4200 MULTIPONTO

PUXADOR SIMPLES

	I. Esc.	I. Polido
400mm	76065	
600mm	76067	
800mm	76069	
1000mm	76070	76071

PUXADOR DUPLO

	I. Esc.	I. Polido	Black
400mm	76056	76057	
600mm	76058	76059	76804
800mm	76060	76061	76805
1000mm	76062	76063	76803
1200mm	76645		
1500mm	76646		

FABRICADO COM

AÇO INOX 304

Composição

> Aço inox 304 / Aço / PVC / Alumínio

Aplicação

> Puxador para portas de madeira ou vidro.

Especificação

> Puxador duplo retangular com perfil 40x20x1mm produzido em aço inox 304

> Sistema de fixação externa que contribui para segurança*.

*sem parafusos externos aparentes

Tamanho (milímetros)

> 400 / 600 / 800 / 1000 / 1200 / 1500mm

(Comprimento total - mm)

RETANGULAR

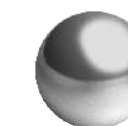

Inox Polido

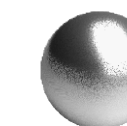

Inox Escovado

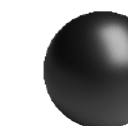

Black



Modelo	Distância Entre Furos
400mm	400mm
600mm	600mm
800mm	800mm
1000mm	1000mm
1200mm	1180mm
1500mm	1480mm

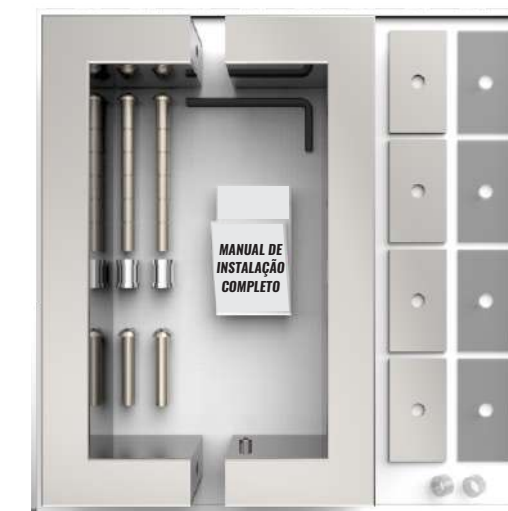

NOVO
ACABAMENTO
BLACK



PUXADOR
MONZA
2020

MONZA 2020



CONHEÇA A
FECHADURA STAM
PARA PORTAS DE CORRER
1008

PUXADOR DUPLO		
	I. Esc.	I. Polido
400mm	76531	76532
500mm	76533	76534
600mm	76535	76536
800mm	76537	76538

FABRICADO COM
AÇO INOX 304

Composição
> Aço Inox 304 / Aço / PVC / ABS / Nylon / Alumínio

Aplicação
> Puxador para portas de madeira ou vidro

Especificação
> Puxador duplo quadrado com perfil 20x20mm em aço inox 304
> Sistema de fixação externa que contribui para segurança*.
*sem parafusos externos aparentes

Tamanho (milímetros)
> 400 / 500 / 600 / 800
(Comprimento total - mm)

Modelo	Distância Entre Furos
200mm	200mm
400mm	400mm
500mm	500mm
600mm	600mm
800mm	800mm

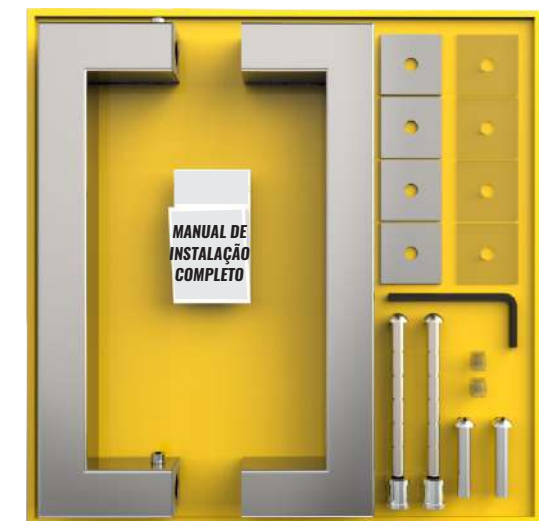

QUADRADO



Inox Polido

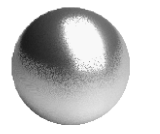

Inox Escovado

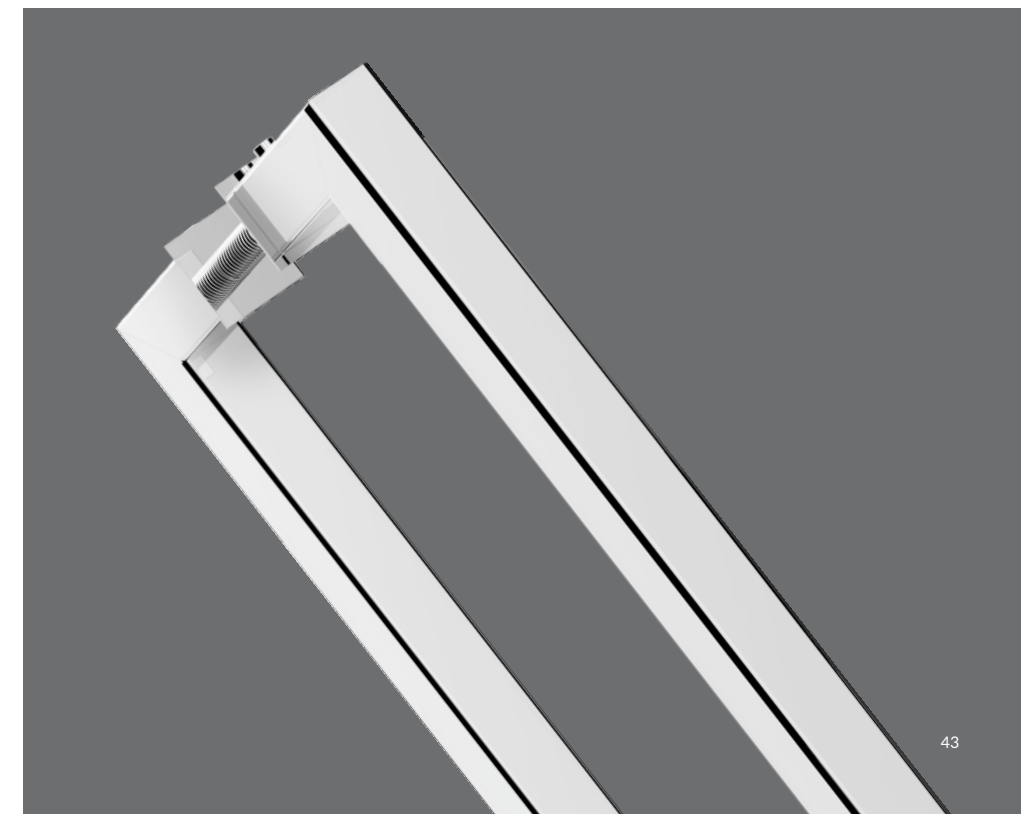

CONCHA

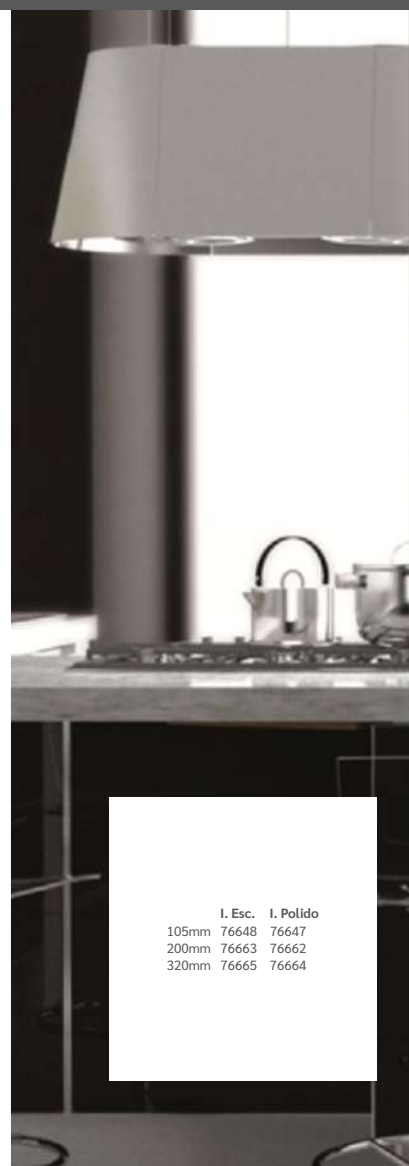

I. Esc. I. Polido
105mm 76648 76647
200mm 76663 76662
320mm 76665 76664



FABRICADO COM

AÇO INOX 304

Composição
> Aço inox 304

Aplicação
> Puxador para portas com abertura por dobradiças, portas de correr, gavetas e móveis.

Especificação
> Puxador concha

Tamanho (centímetros)
> 10,5 x 4,5cm
> 20 x 4,5cm
> 32 x 4,5cm

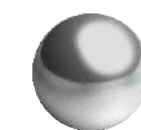
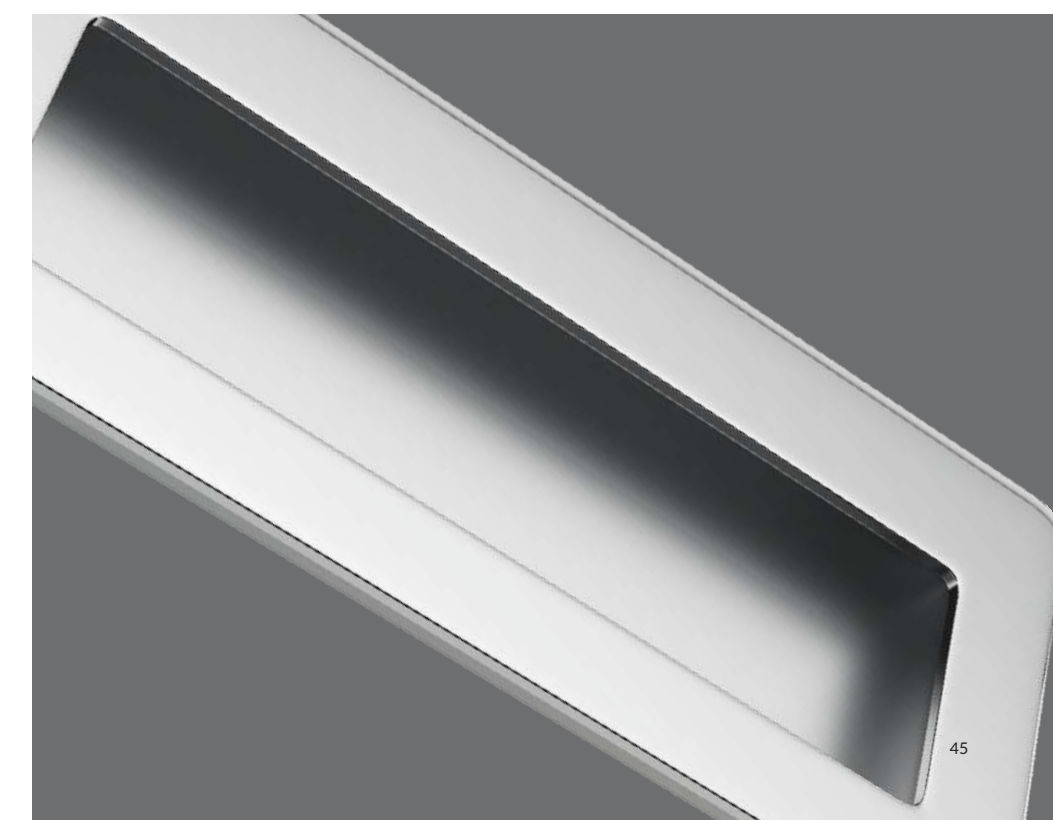

Inox Polido

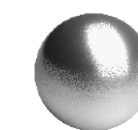

Inox Escovado



Sam

KITS PARA PORTA
DE CORRER

CRYSTAL



	I. Esc.	I. Polido
1,50m	76600	76601
2,00m	76602	76603
2,50m	76604	76605
3,00m	76606	76607

FABRICADO COM

AÇO INOX 304

Composição

> Aço inox 304 / ABS / Acetal / PVC

Aplicação

> Portas de correr em vidro para fins diversos.

Especificação

> Trilho retangular em perfil 40x15x1,2mm em aço inox 304.
> Possui regulagem que permite corrigir desníveis de até 3mm em cada extremidade.

Medida (metro)

> 1,50m / 2,00m / 2,50m / 3,00m

Espessura máxima do vidro

> 10mm*

*O peso máximo da porta deve ser respeitado. O vidro de 8mm tem um peso aproximado de 25Kg/m² e o de 10mm tem um peso aproximado de 30Kg/m²

Peso máximo da porta

> 80kg

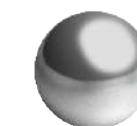

Inox Polido

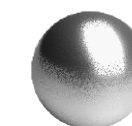

Inox Escovado



SISTEMA DE GUIA

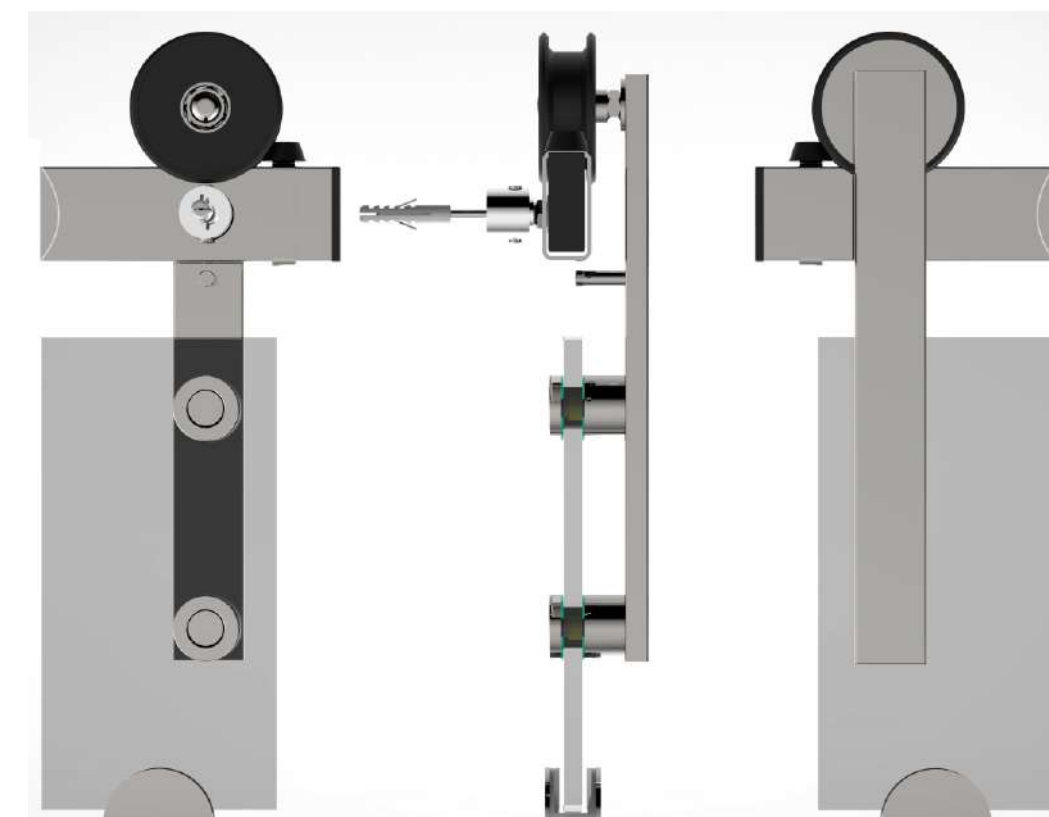

SMART



I. Esc. I. Polido
1,50m 76334 76335
2,00m 76336 76337
2,50m 76338 76339

FABRICADO COM

AÇO INOX 304

Composição

> Aço inox 304 / Alumínio / Acetal / Nylon / Borracha / Aço

Aplicação

> Portas de correr
> Portas de madeira

Especificação

> Trilho retangular em perfil 30x10x1,00mm em aço inox 304.
> Roldanas mais delicadas com Ø58mm.
> Possui guia em nylon que dispensa o uso do Trilho U em alumínio na parte inferior da porta, eliminando o ruído comum em outros sistemas.

Medida (metro)

> 1,50m / 2,00m / 2,50m

Peso máximo da porta

> 40kg

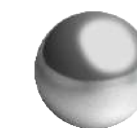
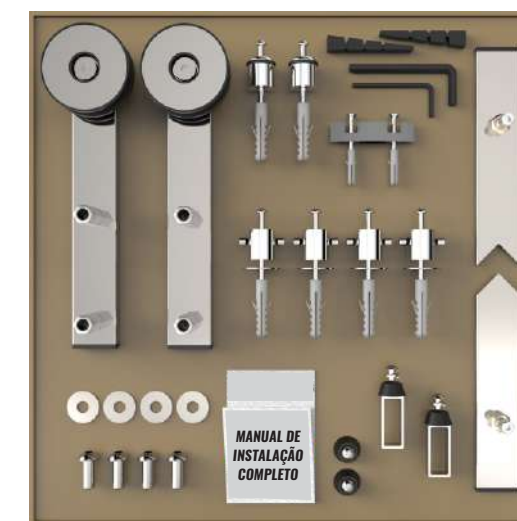

Inox Polido

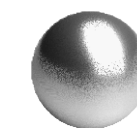

Inox Escovado

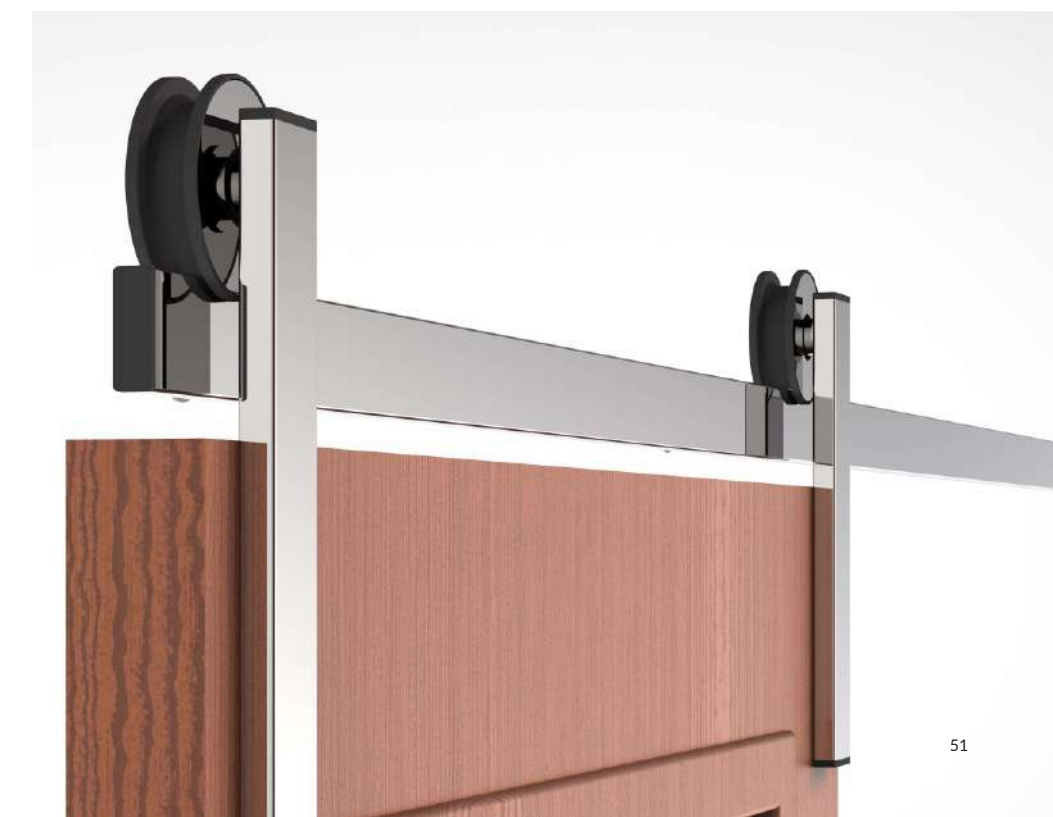

FIT



	I. Esc.	I. Polido
1,50m	76608	76609
2,00m	76610	76611
2,50m	76612	76613
3,00m	76614	76615

FABRICADO COM

AÇO INOX 304

Composição

> Aço inox 304 / Alumínio / Acetal / Nylon / Borracha / Aço

Aplicação

- > Portas de correr.
- > Portas de madeira (sobrepôr).
- > Ideal para instalação de portas com espelho*.

* O peso do espelho deve ser somado ao peso da porta para garantir a resistência do produto

Especificação

- > Trilho retangular em perfil 30x10x1,00mm em aço inox 304.
- > Roldanas fixadas na parte superior da porta, permitindo a instalação de espelho ou outro acabamento. Disponibiliza de kit para fixação de puxador STAM em porta com espelho.
- > Possui guia em nylon que dispensa o uso do Trilho U, eliminando o ruído comum em outros sistemas.

Medida (metro)

> 1,50m / 2,00m / 2,50m / 3,00m

Peso máximo da porta

> 50kg

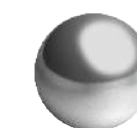
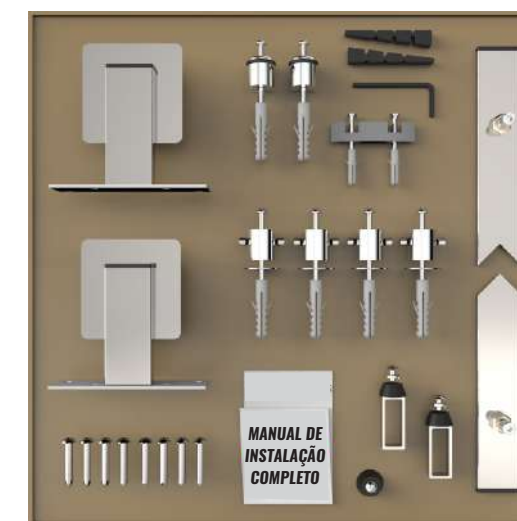

Inox Polido

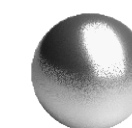

Inox Escovado



MASTER



	I. Esc.	I. Polido
1,50m	76619	76620
2,00m	76621	76622
2,50m	76623	76624
3,00m	76616	76618

FABRICADO COM

AÇO INOX 304

Composição

> Aço inox 304 / Alumínio / Acetal / Nylon / Borracha / Aço

Aplicação

> Portas de correr
> Portas de madeira

Especificação

> Trilho retangular em perfil 40x15x1,2mm em aço inox 304.
> Possui regulagem que permite corrigir desníveis de até 3mm em cada extremidade.
> Disponibiliza de chave de boca para regulagem de trilho.
> Possui guia em nylon que dispensa o uso do Trilho U em alumínio na parte inferior da porta, eliminando o ruído comum em outros sistemas.

Medida (metro)

> 1,50m / 2,00m / 2,50m / 3,00m

Peso máximo da porta

> 80kg

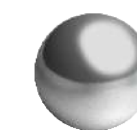
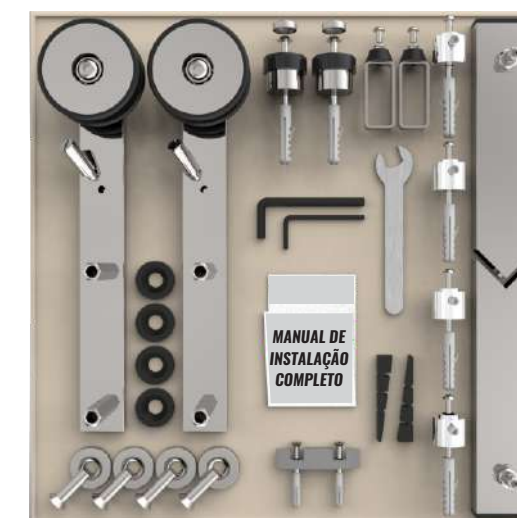

Inox Polido

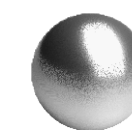

Inox Escovado



IPANEMA F1



1. Polido
1,50m 76653
1,80m 76654
2,00m 76655

FABRICADO COM

AÇO INOX 304

Composição

> Aço inox 304 / Zamac / Alumínio / Acetal / Nylon / PVC / Aço

Aplicação

> Indicado para box de banheiro com vão reto
> Portas de vidro

Especificação

> Trilho retangular em perfil 40x15x1,00mm em aço inox 304.
> Fixações laterais.
> Acompanha perfil em PVC para parede e piso.

Medida (metro)

> 1,50m / 1,80m / 2,00m

Espessura máxima do vidro

> 08mm*

*O peso máximo da porta deve ser respeitado.
O vidro de 08mm tem um peso aproximado de 25Kg/m².

Peso máximo da porta

> 80kg

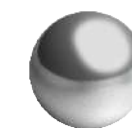

Inox
Polido



PARA BOX
DE BANHEIRO

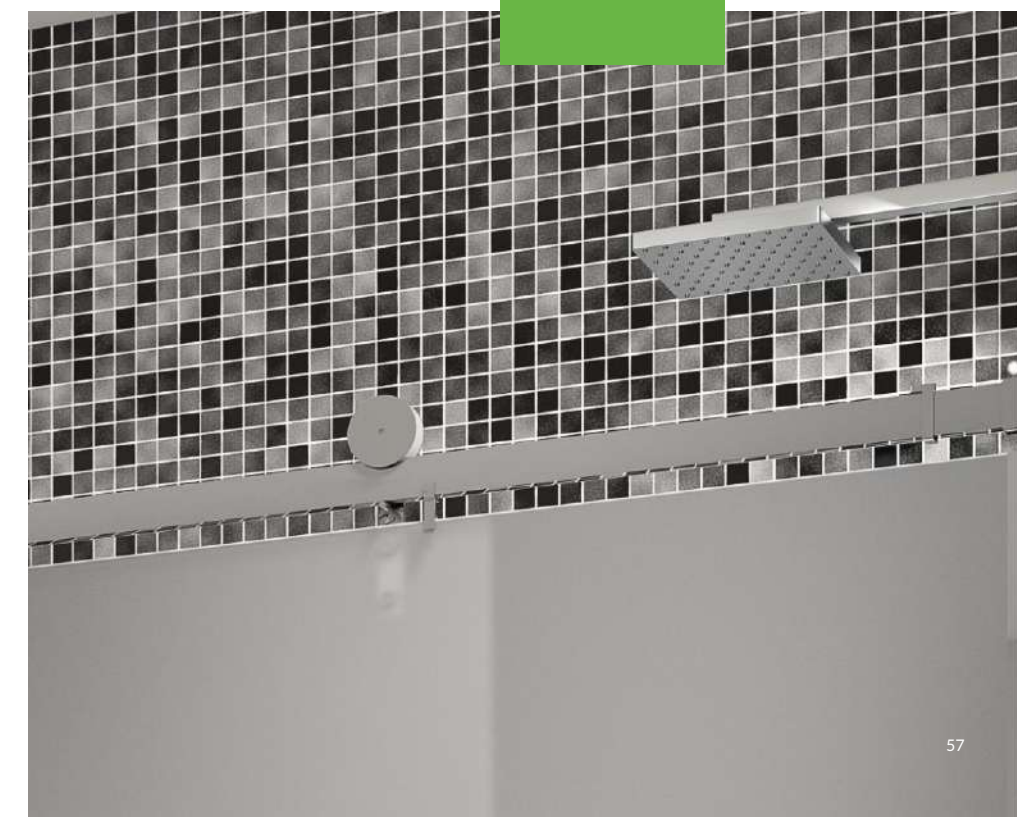

IPANEMA C1



1. Polido
0,90m 76651
1,20m 76652

FABRICADO COM

AÇO INOX 304

Composição

> Aço inox 304 / Zamac / Alumínio / Acetal / Nylon / PVC / Aço / Componente Magnético / Ferrite

Aplicação

> Indicado para Box de banheiro em L
> Portas de vidro.

Especificação

> Trilho retangular em perfil 40x15x1,00mm em Aço inox 304.
> Fixações laterais.
> Acompanha perfil em PVC para parede e piso.

Medida (metro)

> 0,90m / 1,20m

Espessura máxima do vidro

> 08mm*

*O peso máximo da porta deve ser respeitado.
O vidro de 08mm tem um peso aproximado de 25Kg/m².

Peso máximo da porta

> 80kg

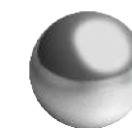

Inox
Polido



PARA BOX
DE BANHEIRO

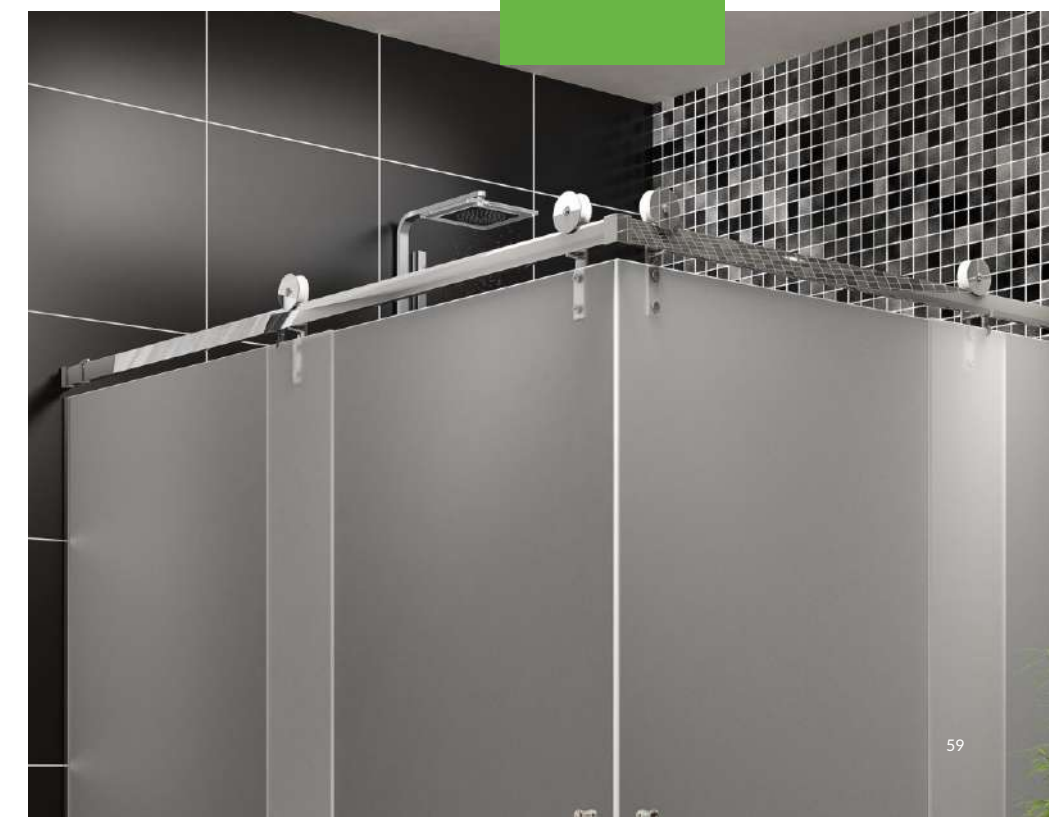

Sam

DOBRADIÇAS

DOBRADIÇA DE EMBUTIR



Encartelado	I. Esc.	I. Polido
3" X 2 1/2"	76005	76006
3 1/2" X 3"	76014	76015
Caixa	I. Esc.	I. Polido
3" X 2 1/2"	76003	76002
3" X 3"	76009	76010
3 1/2" X 3"	76013	76023
Caixa	I. Esc.	I. Polido
4" X 3"	76016	76017

FABRICADO COM

AÇO INOX

COM ROLAMENTO

Composição

> Aço Inox

Espessura

> 1,9mm (modelos 3" x 2 1/2", 3" x 3", 3 1/2" x 3")

> 2,4mm (modelo Reforçada 4" x 3")

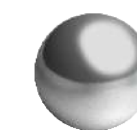

Inox Polido

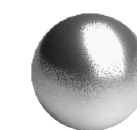

Inox Escovado

3" x 2 1/2"



3" x 3"



3 1/2" x 3"



REFORÇADA 4" x 3"



DOBRADIÇA DE SOBREPOR



Caixa	I. Esc.	I. Polido
	76809	76810
Encartelado	I. Esc.	I. Polido
	76811	76812

FABRICADO COM

AÇO INOX

Composição
> Aço Inox

Espessura
> 2mm

Especificação
> Com rolamento em Aço Inox.

Tamanho (milímetros)
> 100 x 73,5 x 50mm

**NÃO PRECISA DE REBAIXO
OU ENTALHE NA PORTA
E NO BATENTE**

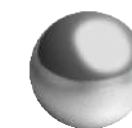

Inox
Polido



DOBRADIÇA PINO PIVOTANTE



	Inox 304
Encartelado	76657
	Zincado
Encartelado	76340
Sacola	76018

FABRICADO COM

AÇO INOX 304

AISI 304

Composição
> Aço Inox 304 / ABS

Peso máximo da porta
> 140 kg



ZINCADO

Composição
> Aço Inox / Aço Zincado / ABS

Peso máximo da porta
> 140 kg





Sam

ACESSÓRIOS

FECHO MAGNÉTICO



Fecho Magnético 76678

Composição

> Nylon / Neodímio / Aço Inox 304

Aplicação

> Utilizado em portas de abrir, portas de correr e janelas.

Especificação

> Auxiliar no fechamento de portas sem o uso de fechadura. Considerando a força de atração dos elementos magnéticos de Neodímio (2 Kgf em tração), podemos citar alguns exemplos:

A - Elimina o incômodo barulho causado por portas que devido a folgas de instalação, balançam por ação de vento ou corrente de ar.

B - Fixa a posição de portas pivotantes e elimina eventuais oscilações causadas por folgas de instalação.

C - Ideal em portas de escritório com uso intenso onde não há necessidade de fechadura.

D - Ideal para portas de entrada e outras portas dos ambientes que necessitam permanecer fechadas sem estar trancadas.

OBS 1:

Para portas leves, utilizar 1 fecho e 2 para portas mais pesadas.

OBS 2: Extremamente fácil de instalar. Bastam 2 furos sendo 1 na lateral da porta e 1 na aduela ou marco da porta.



FIXADOR MAGNÉTICO

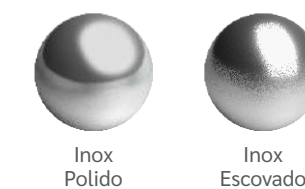

FABRICADO COM

AÇO INOX 304

Composição

> Aço inox 304 / Aço / Nylon / Ferrite / Plástico

Aplicação

> Mantém a porta aberta evitando danos e acidentes.

Especificação

> Possui campo magnético em ambos os lados e pode ser fixado em pisos e rodapés.
> Mola interna para amortecimento de batidas.



INSTALAÇÃO EM
PISOS



INSTALAÇÃO EM
PAREDES / RODAPÉS

I. Esc. I. Polido
Encartelado 76330 76331

FECHO BATOM



I. Esc. I. Polido
 1,50m 76600 76601
 2,00m 76602 76603
 2,50m 76604 76605
 3,00m 76606 76607

FABRICADO COM

AÇO INOX 304

Composição

> Aço inox 304 / Aço / PVC

Aplicação

> Travamento de portas e janelas.

Especificação

> Possui esfera com “click” de abertura e fechamento.
 > Funcionamento suave.

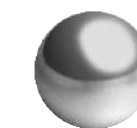

Inox Polido

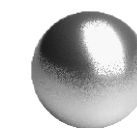

Inox Escovado

O PRODUTO FICA VISÍVEL SOMENTE DE UM LADO DA PORTA



O PRODUTO NÃO FICA VISÍVEL DO LADO DE FORA DA PORTA



BATENTE DE PORTA



I. Esc. I. Polido
Encartelado 76332 76333

FABRICADO COM
AÇO INOX 304

Composição
> Aço inox 304 / Aço / ABS / Plástico

Especificação
> Determina o limite de abertura da porta.

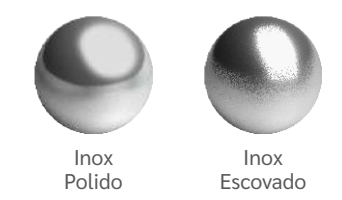

VISOR DE PORTA



	Antique		Cromo Escovado
Encartelado	76002	Encartelado	-----
Caixa	76000	Caixa	76020
	Cromado		Dourado
Encartelado	76019	Encartelado	76021
Caixa	76001	Caixa	76440

FABRICADO COM

AÇO INOX

Composição

> Aço Inox / Zamac / Latão / Resina

Especificação

> Visor de porta com ângulo de 180°*.

*Ângulo real de visão de 165°.

> Possui fechamento interno do visor evitando a entrada de poeira e garantindo a privacidade.



Sam

BARRA DE APOIO

BARRA DE APOIO



I, Polido
400mm 76345
600mm 76346
800mm 76347

FABRICADO COM

AÇO INOX 304

Composição

> Aço inox 304 / Alumínio / PVC

Especificação

- > Perfil Ø32mm produzido em aço inox 304, para parede.
- > Suporta até 150kg de carga sem deformação.
- > Produto em conformidade com a norma ABNT.

Tamanho (milímetros)

> 400mm / 600mm / 800mm

Peso máximo (carga suportada)

> 150kg

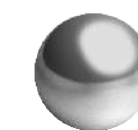

Inox
Polido

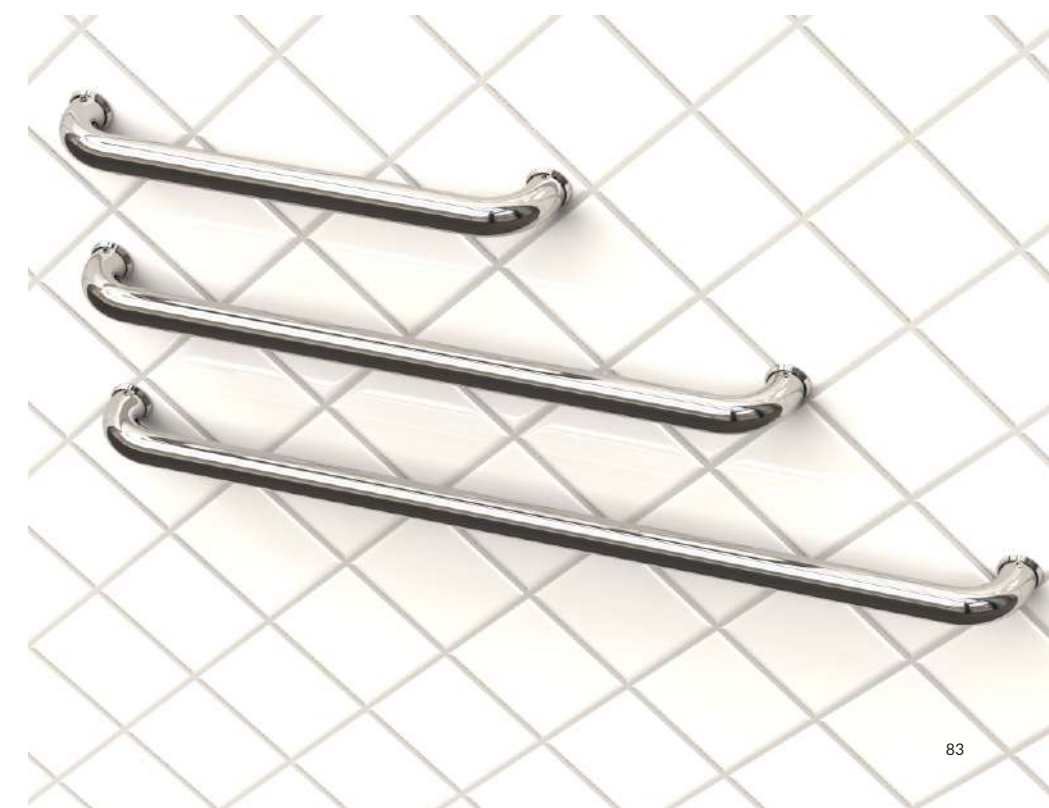

Sam

PÉ DE MESA

PÉ DE MESA



L. Esc. I. Polido
Lisboa 76595 76596
Salamanca 76597 76598

FABRICADO COM

AÇO INOX 304

Composição

> Aço Inox 304 / Alumínio / ABS / Poliuretano*
(*apenas no modelo SALAMANCA)

Aplicação

> Tampo de vidro ou madeira.
Modelo LISBOA - para madeira.
Modelo SALAMANCA - para vidro.

Tamanho (milímetros)

750 x 60mm

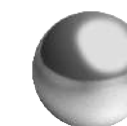

Inox Polido

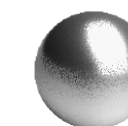

Inox Escovado



stam

Av. Sebastião Martins, 871 . Conselheiro Paulino
Nova Friburgo . Rio de Janeiro . CEP 28635-430
CNPJ 30.560.205/0001-92 - Indústria Brasileira

SAC 0800 024 1020 | STAM.COM.BR



stammetalurgica



stambrasil



stamtube